



USER'S MANUAL

MODEL: 3473-MRD & 3474-MRD

MOTORIZED ROTATING DRIVE

PROPRIETARY

THIS DOCUMENT CONTAINS CONFIDENTIAL INFORMATION PROPRIETARY TO GMW ASSOCIATES. IT MUST NOT BE REPRODUCED OR DISCLOSED TO OTHERS OR USED IN ANY WAY EXCECPT FOR THE INSTALLATION, OPERATION OR MAINTENANCE OF GMW ASSOCIATES PRODUCTS.



TABLE OF CONTENTS

	Page
MOTORIZED ROTATING DRIVE SPECIFICATIONS	4
MOTORIZED ROTATING DRIVE WARNINGS [Refer to this section before operating motorized rotating drive]	6
MOTORIZED ROTATING DRIVE INSTALLATION	
Hardware	
Installation of Motor Drive Option to Rolling/Rotating Base.	7
Motor Drive Assembly Fitting/Removal	
Rolling/Rotating Base Installation	
Stepper Motor Controller	
Software	14
Software Installation	
Software Setup	
MOTORIZED ROTATING DRIVE OPERATION	15
TROUBLESHOOTING/TECHNICAL SUPPORT	17
MOTORIZED ROTATION DRIVER SOFTWARE	19
Software Revision List	
LabVIEW Software Printout	
DRAWINGS	21
Drawing 11900800 Motorized Rotating Drive General Assembly [3473/3472 Electromagnets]	
Drawing 11900801 Motorized Rotating Drive General Assembly [3474 Electromagnet]	
Drawing 11900810 Motorized Rotating Drive -Motor Drive Assembly [3473/3472 Electromagnets]	
Drawing 11900811 Motorized Rotating Drive -Motor Drive Assembly [3474 Electromagnet]	
Drawing 11900820 Motorized Rotating Drive Spool Assembly	
Drawing 11900840 Motorized Rotating Drive Stop Block Assembly	
Drawing 11900850 Motorized Rotating Drive Worm Mount Assembly	
Drawing 11901020 Motorized Rotating Drive Electrical Assembly	
Drawing 13900350 Motorized Rotating Drive Electrical Wiring	
Drawing 11902620 Motorized Rotating Drive/Base Floor Installation [3473/3472 Electromagnets]	
Drawing 11902621 Motorized Rotating Drive/Base Floor Installation [3474 Electromagnet]	
Drawing 11902640 Motorized Rotating Drive Installation Kit	
Drawing 11902650 Motorized Rotating Drive Spare Parts Kit]	

TABLE OF CONTENTS

DRAWINGS (continued)

Drawing 11803430 Rolling/Rotating Base [3473/3472 Electromagnets]

Drawing 11803170 Rolling Base [3473/3472 Electromagnets]

Drawing 11802090 Rotating Base [3473/3472 Electromagnets]

Drawing 11900980 Rolling/Rotating Base [3474 Electromagnet]

Drawing 11801800 Rolling Base [3474 Electromagnet]

Drawing 11900990 Rotating Base [3474 Electromagnet]

DRIVER CD

[located in pouch inside back cover]

SPECIFICATIONS
Table 1. Model 3473-MRD Specifications

Rotation angle [from zero point]	+/- 200 deg max
Rotation repeatability	+/- 0.1 deg max
Rotation accuracy	+/- 0.2 deg max
Mechanical stops	+/- 200 deg max
Limit switches	+/- 195 deg max
Homing switch	0.0 deg
Drive system	
Gear type	Worm/Worm Gear
Mechanical reduction	100:1
Stepper motor	
Motor type	Zeta 83-135
Motor part no	ES33B-DFR10
Motor torque	2.7N.m (382 oz.in)
Motor frame size	34
Stepper motor controller	Compumotor Zeta 6104
Rotation axis scaling	approx. 6944 steps/deg
Software	
Motion architect [Supplied by Parker Hannifin]	
LabVIEW driver [Supplied by GMW Associates]	

SPECIFICATIONS
Table 1. Model 3474-MRD Specifications

Rotation angle [from zero point]	+/- 200 deg max
Rotation repeatability	+/- 0.2 deg max
Rotation accuracy	+/- 0.3 deg max
Mechanical stops	+/- 200 deg max
Limit switches	+/- 195 deg max
Homing switch	0.0 deg
Drive system	
Gear type	Worm/Worm gear
Mechanical reduction	100:1
Stepper motor controller	Compumotor Zeta 6104
Stepper motor	
Motor type	Zeta 83-135
Motor part no	ES33B-DFR10
Motor torque	2.7N.m (382 oz.in)
Motor frame size	34
Stepper motor controller	Compumotor Zeta 6104
Rotation axis scaling	approx. 6944 steps/deg
Software	
Motion architect [Supplied by Parker Hannifin]	
LabVIEW driver [Supplied by GMW Associates]	

WARNINGS

[Refer to this section before operating motorized rotating drive]

Motorized rotating drive and electromagnet are under computer control. They may rotate at any time, personnel must remain clear.

Do not operate motorized rotating drive with the rolling base skirt panels removed.

Do not operate rolling/rotating base until it is secured in its final location.

It is recommended the rolling/rotating base is secured to an adequate concrete floor to prevent movement and possible injury to personnel during an earthquake.

Arrange cables and hoses so that they do not foul the worm/worm gear on the motor drive mechanism.

MOTORIZED ROTATING DRIVE INSTALLATION

Hardware

[Refer to this section only if MRD is not installed by GMW]

Introduction

The procedure to install the Motorized Rotating Drive Option onto an existing rolling/rotating base, is similar for either the 3473/3472/5403 or 3474 systems. Only one system installation is described in this manual. Refer to drawing no 11900800 for the 3473/3472/5403 system, and drawing no 11900801 for the 3474 system.

Installation of Spool Assembly and alignment to Rolling/Rotating Base

1. Firstly remove all the skirt panels from the rolling base.
2. Remove the M12 SHCS at locations 1 to 4 on the transition plate.
3. Install two M16 lifting eyebolts into two diagonal opposite corners of the transition plate.
4. Place spool assembly dwg no: 11900820 on top of assembly table, with the worm gear closest to table surface. Take care not to damage the worm gear.
5. Fit item 4 on drawing 11900801 Spool Spacer on top of spool assembly [3474 system only].
6. Using suitable lifting equipment raise the transition plate, and place on top of spool/spool spacer assembly. Check transition plate is correct side up. Counter bored holes should be on the top side.
7. Ensure the zero button on the spool assembly faces the front of the transition plate.
8. Secure the spool assembly to the transition plate with three M10 SHCS and lock washers at locations marked A, C, and E, on dwg no: 11900800/11900801. Tighten finger tight only.
9. Install spool alignment bush onto M10 SHCS and washer as shown on Drawing no: 11902640. Note wide end of alignment bush and washer fit under M10 SHCS head.
10. Fit alignment bush and M10 SHCS into the remaining spool assembly securing locations. They are marked B, D, and F, on dwg no: 11900800/11900801. Tighten finger tighten only.
11. Undo the rotation locks and rotate the rotating ring of the rotating base so that it is set to 0 deg. Then lock in place with the rotation locks.
12. Using suitable lifting equipment raise the transition plate and spool assembly, and move above the rolling/rotating base.
13. Rotate the transition plate and spool assembly so that the zero button is aligned with the rotating base top ring 0 deg position.

MOTORIZED ROTATING DRIVE INSTALLATION

Hardware

[Refer to this section only if MRD is not installed by GMW]

Installation of Spool Assembly and alignment to Rolling/Rotating Base [continued]

14. Slowly lower the transition plate spool assembly into the hole through the rotation base and rolling base assemblies. Take care not to damage the bronze worm gear at the bottom of the spool assembly.
15. Recheck the zero button is aligned with the 0 deg on the rotating ring of the rotating base.
16. Secure the spool /transition plate assembly with two M12 SHCS and M12 lock washers at locations marked 1, and 3. on dwg no: 11900800/11900801. Tighten finger tight only.
17. Install transition plate alignment bush onto M12 SHCS and washer as shown on Drawing no: 11902640. Note wide end of alignment bush and washer fit under M12 SHCS head
18. Fit transition plate alignment bush and M12 SHCS into the holes marked at locations 2 and 4 on dwg no: 11900800/11900801. Tighten finger tight only.
19. Next step is to align the spool assembly to the transition plate. Tighten the three M10 SHCS and spool alignment bushes at locations marked B, D, and F.
20. Fully tighten the three M10 SHCS at locations marked A, C, and E.
21. Remove the M10 SHCS and the spool alignment bushes at locations marked B, D, and F.
22. Install correct length M10 screws and lock washers, at locations B, D, and F and fully tighten.
23. Tighten the two M12 SHCS and transition plate alignment bushes at locations marked 2 and 4. Then tighten the two remaining M12 SHCS at locations 1 and 3.
24. Attach a dial indicator with a magnetic clamp to the underside of the rolling base top plate. Position the dial indicator probe so that it contacts the spool outer surface.
25. Undo the rotational locks. Rotate the rotating base from 0 through 360 deg and check the runout with the dial indicator. Maximum runout should be within: +/- 0.2mm.
26. Remove the two M12 SHCS and alignment bushes at locations 2 and 4, and reinstall original M12 SHCS and lock washers.
27. If no further alignment is required then fully tighten the M12 SHCS at locations 1 thru 4.
28. If further alignment is required loosen the four M12 SHCS at locations 1 thru 4 and set so that they are finger tight.
29. Tap edge of transition plate to move as required to achieve runout specifications above. When runout specifications are met, fully tighten the M12 SHCS at locations 1 thru 4

MOTORIZED ROTATING DRIVE INSTALLATION

Hardware

[Refer to this section only if MRD is not installed by GMW]

Installation of Motor Drive Assembly to Rolling/Rotating Base (see drawing no 11900800/1)

1. Firstly install the ball plungers into the motor drive assembly guides. Note only the ball part of the plunger should protrude into the inside surface of the guide.
2. Fit the motor drive assembly guides to the underneath side of the rolling base using M8 SHCS and M8 ribbed lock washer. Note the locking detents must face to the front edge of the rolling base. Leave the M8 SHCS screws finger tight.
3. Place the disengage lever in the released position on the motor drive assembly.
4. Undo the rotational locks on the rotating base and rotate to the 0 deg position.
5. Slide the motor drive assembly into the motor drive guides . (Located on the front underneath surface of the rolling base
6. Squeeze the two release pins together and slide the motor drive assembly forward slowly until the lock bars just enter the motor drive assembly guides.
7. Move the motor drive assembly slowly inward with the release pins unrestrained until the motor drive assembly locks into the motor drive assembly guides detents.
8. Move the disengage lever to the engaged position while rocking the rotating base backwards and forwards slightly. The worm on the motor drive assembly will engage the worm gear on the spool assembly.
9. Fit G clamps to the outside surface of both the motor drive assembly guides. Adjust pressure to remove excessive play between the guides and the motor drive assembly. Tighten the M8 SHCS mounting screws. Move the disengage lever to the engage and disengage positions it should move freely. Readjust as required.
10. Measure the difference between the worm drive shaft centerline and the worm gear tooth centerline on the spool assembly. Record the difference, it will be within the range of 0 to 3mm.
11. Remove the motor drive assembly by squeezing the two release pins together and then sliding the motor drive assembly out of the motor drive assembly guides.
12. Refer to drawing no: 11900810/1. The worm and worm gear must be aligned on the same centerline to ensure correct gear meshing. Undo the four M6 SHCS and remove the worm drive and timing belt. Remove or add shim washers in four equal stacks to obtain the correct height required for the worm assembly. Reassemble the worm drive assembly using the four M6 SHCS and ribbed lockwashers, but leave finger tight. Do not refit the timing belt at this stage.

MOTORIZED ROTATING DRIVE INSTALLATION

Hardware

[Refer to this section only if MRD is not installed by GMW]

Installation of Motor Drive Assembly to Rolling/Rotating Base (see drawing no 11900800/1)

13. Reinstall the motor drive assembly refer to steps 5, 6, 7, and 8 above.
14. Slide the worm mount on the motor drive assembly forward until it is fully meshed into the teeth of the worm gear on the spool assembly. Tighten the four M6 worm assembly mounting screws.
15. Rotate the rotating base back and forth by slight hand force. If correct there should be no backlash in the system. If excessive backlash is found readjust as described above.
16. Remove the motor drive assembly by squeezing the two release pins together and then sliding the motor drive assembly out of the motor drive assembly guides.
17. Mark the position of the worm drive assembly relative to the stop block assembly.
18. Loosen the four M6 mounting screws and move the worm drive assembly backwards 0.1 to 0.2mm. This is the system backlash.
19. Retighten the four M6 mounting screws on the worm drive assembly.
20. Loosen the two M6 SHCS securing the stepper motor mounting bracket to the base plate.
21. Move the stepper motor towards the worm mount assembly.
22. Fit the timing belt.
23. Slide the motor away from the worm mount assembly until the belt is tight.
24. While holding the motor away from the worm mount assembly, tighten the motor mounting bracket M6 securing screws.
25. To check belt tension apply slight finger force in the middle of the belt. It should deflect approximately 3mm. Readjust if required as described above.
26. Reinstall motor drive assembly as described above.
27. Install the cable support with the M8 SHCS, flat and lockwasher as shown on dwg no: 11900800 and dwg no: 11900801.
28. Rotate the motor drive assembly cable around the cable support so that the cable enters the inside of the cable support. The cable should be free to slide within the cable support.

MOTORIZED ROTATING DRIVE INSTALLATION

Hardware

[Refer to this section only if MRD is not installed by GMW]

29. Recheck the motor drive assembly guide securing screws are tight.
30. Apply grease to the worm/worm gear as detailed on dwg no: 11900800/1
31. Refit both side skirt panels to the rolling base.
32. Located on the rear skirt panel is a rubber blank grommet. Remove grommet and cut center out and split along the radius.
33. Open grommet along radial split. Thread motor drive cable into grommet.
34. Push grommet into rear skirt panel cutout located in the middle of the skirt panel.
35. Refit rear skirt panel to rolling base. Take care not to trap the cable between the rolling base and the skirt panel.
36. Fit the disengage/engage label to the front skirt panel.
37. Fit the front skirt panel to the rolling base.
38. Fit the two caution labels to the rolling base top plate surface as shown.

Running In Motorized Rotating Drive system.

1. Remove Stop Block assembly from inside spool assembly. Undo four SHCS and lockwashers on the stop block assembly and remove. Refer dwg no: 11900820.
2. Run the MRD system at fast velocity setting i.e 2 to 5 for approximately one hour to bed in the worm and worm gear.
3. Finally reinstall the stop block assembly.

The motorized rotating drive option is now fully installed, refer to the following sections for operating instructions.

MOTORIZED ROTATING DRIVE INSTALLATION

Hardware

Motor Drive Assembly Removal (see drawing no 11900800/1)

1. Remove front and rear skirt panels on rolling base.
2. Place the disengage lever in the released position.
3. Squeeze the two release pins together and slide the motor drive assembly outward until the motor drive assembly clears the mounting guides..
4. Rotate the motor drive assembly cable around the cable support so that the cable releases from the cable support.

Motor Drive Assembly Fitting (see drawing no 11900800/1)

1. Slide the motor drive assembly into the motor drive guides .
2. Squeeze the two release pins together and slide the motor drive assembly forward slowly until the lock bars just enter the motor drive assembly guides.
3. Move the motor drive assembly slowly inward with the release pins unrestrained until the motor drive assembly locks into the motor drive assembly guides detents.
4. Rotate the motor drive assembly cable around the cable support so that the cable enters the inside of the cable support. The cable should be free to slide within the cable support.
5. Fit motor drive assembly cable into grommet on rear skirt panel.
6. Replace back skirt panel on rolling base.
7. Replace front skirt on rolling base.
8. Move the disengage lever to the engaged position while rotating the electromagnet slightly and slowly back and forth. The lever will lock in the engaged position.

Rolling/Rotating Base Installation (refer to electromagnet user's manual for more details).

1. First fit electromagnet to rolling/rotating base, and move to desired location.
2. If magnet cable and hoses enter rotating base from floor it is recommended to fit floor spacers to provide additional clearance for the hoses and cables. See drawing no: 11902620 and 11902621. Level the base as detailed below.
3. If cables and hoses enter from above magnet/rolling/rotating base then the floor spacers are not needed. It is important that the base is leveled in its final location. Screw down the four support legs located on each corner of the rolling or rolling/rotating base until the wheels clear the floor by 6mm (.25"). Check the base is level in both directions. Then secure the support legs with the locknut.
4. Secure rolling/rotating base to an adequate concrete floor to prevent movement and possible injury to personnel during an earthquake.

MOTORIZED ROTATING DRIVE INSTALLATION

Hardware

Stepper Motor Controller Installation (see drawing no 11901020)

1. Connect the motor drive assembly cable to the stepper motor controller. Cable has two plugs, one connects the motor power and the other connects the limit and homing wiring to the controller.
2. Connect the serial communications cable into Com 1 on the stepper motor controller.
3. Connect the other end of the serial communications cable into the control computer's serial port.
4. Check the Controller input power requirement, normally 115V. Connect the AC power cord to the stepper motor controller and the other end to the correct voltage outlet.

MOTORIZED ROTATING DRIVE SETUP

Software

Software Requirements

- PC with Intel Pentium/Celeron family, or AMD K6/Athlon/Duron family, or compatible processor, 300 megahertz or higher processor clock speed recommended
- 512Mb RAM memory required, 1Gb RAM memory or more recommended.
- CD-ROM drive or DVD drive for software installation.
- USB 2.0 port for using USB-RS232 converter. If native Serial port present, USB port is not required for Motorized Rotating Drive Software.
- SVGA monitor running 1024 x 768 pixels. ^[Note1]
- Windows XP Operating System software.
- LabVIEW for Windows V8.2 or later. ^[Note 2]
Motorized Rotating Drive software can also be supplied as an executable file and run directly from the Windows Operating System. In this case LabVIEW for Windows V8.2 is not required.

Software Installation

The Motorized Rotating Drive LabVIEW driver and support files are all located in a directory called MRDrive.

To install the driver follow the directions given below.

1. Insert CD of the Motorized Rotating Drive software into CD-ROM Drive.
2. Open the Windows Explorer to access the software in CD.
The software on the CD is located at directory CD drive:\MRDRIVE\LabVIEW 8.2
MRD.prg Setup file for Zeta stepper motor controller.
MRD V2.0a.llb MRD driver library file. [All sub VI's are inside the llb file]
The top level vi is: MRD Driver.V2.0a.vi
3. Copy the files on CD to computer hard drive in a proper directory.
Note: MRD.prg and MRD V2.0a.llb must be in same directory.

Before running the Motorized Rotating Drive software set the Com Port control to match the Com Port being used on the control computer.

Note:

1. Using screen resolutions other than 1024 x 768 means all items on the LabVIEW front panels will have to be resized by the end user.
2. **The executable program file cannot be altered by the end user.** Consult GMW if the Motorized Rotation Drive software is required as an executable file.

MOTORIZED ROTATING DRIVE OPERATION

To Start the Motorized Rotating Drive Software

Click the LabVIEW **Run** button or use CTRL+R on the keyboard.

When the software starts running, message “Sending Setup File to Zeta Controller *Please Wait*” appears. It should stay on for several seconds. Do not operate the software at this stage. After several seconds another message should appear: “System Running. The system is then ready for accepting commands.

To Stop the Motorized Rotating Drive Software

Click the blue **STOP PROGRAM** button located at the lower RH corner of the screen. Use this button to stop the software at all times if possible. Any other way of terminating the software will possibly cause serial port communications problems. To restore communications sometimes requires rebooting the host computer.

Motorized Rotating Drive Software Default Settings

The Magnet Control System software will open with all parameters set to the default settings. To change the default of a control follow the instructions listed below.

1. First stop the software by clicking on the STOP PROGRAM button.
2. Then set the control to the desired default value.
3. Right mouse click on the control and select Data Operation.
4. Click on the selection Make Current Value Default. Save the new setting.
5. Restart the Motorized Rotating Drive Software by clicking on the LabVIEW run arrow at the top left screen.

Motorized Rotating Drive Software Help

On screen help is available. To use the on line help use a **CTRL + H** from the keyboard to open the help window, and then move the cursor over the control or indicator on the front panel. A description of the control or indicator function will appear in the help window.

SETUP PANEL

- MRD Port:** Click on the Drop-Down arrow button. Selects the computer serial port used to communicate with the stepper motor controller.
- Motor Controls:** Sets the velocity value, acceleration value of the stepper motor.
- Home Motion Controls:** Sets the acceleration, deceleration and velocity of the stepper motor when homing to the 0.0 deg position.
- AUTO START ON/OFF:** When AUTO START is set to **ON** the Set Position [deg] is controlled by the Up and Down arrows on the computer keyboard. A position value can also be directly entered from the numeral keypad. By default the lowest significant digit is controlled and rolls over to the next highest digit. Roll over occurs between the lowest to the most significant digit. Press the ENTER key to start rotation to the set position.
- GO TO SET POSITION:** Click on the GO TO SET POSITION button will start the motion to the position defined by Set Position [deg] control.

MOTORIZED ROTATING DRIVE OPERATION

[Continued]

MAGNET ROTATION CONTROLS

- Home CW Control:** Makes the motorized rotating Drive rotate in a clockwise direction until it finds the home position at 0.0 deg and resets the current position counter to 0.0 deg. [\[See initial setup information below\]](#)
- Home CCW Control:** Makes the motorized rotating Drive rotate in a counterclockwise direction until it finds the home position at 0.0 deg and resets the current position counter to 0.0 deg. [\[See initial setup information below\]](#)
- Counter Reset Control:** Resets the current position counter to 0.0 deg.
- Velocity Value Control:** Sets the velocity of the stepper motor.
- Acceleration Value Control:** Sets the acceleration of the stepper motor.
Note: Velocity and Acceleration value settings only change while motor is in motion. The values for both velocity and acceleration are relative values, not absolute value.
- Start Motion CCW Control:** Starts the motorized rotating drive rotating in a counterclockwise direction until limit switch is reached, or the **Stop Motion** button is pushed.
- Start Motion CW Control:** Starts the motorized rotating drive rotating in a clockwise direction until limit switch is reached, or the **Stop Motion** button is pushed.
- Stop Motion Control:** Stops the motorized rotating drive rotating at any time.
- Emergency Stop Control:** Stops the motorized rotating drive rotating INSTANTLY.
Since this action puts high strain on all mechanical components, only use in an emergency.
- Stop Program Control:** Stops the motorized rotation drive software running.

MAGNET ROTATION STATUS

Actual Position Indicator: Shows the motorized rotation drive current position on a digital display. Units are in degrees from the initialized zero position.

System Initial Setup

Press either the Home CW or Home CCW button. The base will rotate to approximately the 0 deg position and stop. Set the Velocity to 0.1 and move the base to exactly the 0 deg position using either the CW or CCW buttons. Once the base is aligned on the 0 deg position, press the Counter Reset button. The system is ready to be used. Note if the stepper motor controller is reset then this process must be repeated.

Hardware Limits

The hardware CCW and CW limit switches operate at approximately -195 deg and +195 deg respectively. After the limit switch has operated the rotation of the motorized rotating drive will decelerate at the same rate as set by the software acceleration control setting and then stop. A 5 deg overrun has been allowed for before the mechanical stops operate.

Mechanical Stops

The mechanical stops operate at -200 deg and +200 deg stopping any rotation beyond these positions.

TROUBLESHOOTING/ TECHNICAL SUPPORT

Troubleshooting

Symptom 1: Clicking sound coming from stepper motor while base is rotating [motor stalling].

Cause of Problem:

- [a] Worm/Worm Gear not lubricated.
- [b] Timing belt not set to correct tension, causing belt to slip during operation.
- [c] Spool assembly not running concentrically with rotating base.
- [d] Worm/Worm Gear not aligned with each others centerline.
- [e] Worm/Worm Gear meshed too tight together.
- [f] Pulley slipping on either stepper motor, or worm assembly shaft.
- [g] Rolling/Rotating base is not level.
- [h] Too much friction in the rotating base.
- [i] Cables or hoses stopping free rotation of rotating base.
- [j] Running stepper motor at too higher speed.

Recommend velocity setting of 0.5 for 3474 MRD, and 1.0 for 3473 MRD.

Remedy: Diagnose fault, and refer to the appropriate section of this manual for corrective action.

Symptom 2: Rotating Base does not rotate to correct position.

Cause of Problem:

- [a] Controller has lost rotational reference point.

Remedy: Follow instructions for System Initial Setup.

Symptom 3: No rotation from rotating base.

Cause of Problem:

- [a] No AC power to Zeta controller.
- [b] Serial communications cable not connected to host computer.
- [c] Motor and limit switch cable not connected to Zeta controller.

Remedy: Check system wiring and AC power.

TROUBLESHOOTING/ TECHNICAL SUPPORT

Technical Support:

Technical support is available by contacting GMW by Telephone, Fax or Email.

GMW Associates
955 Industrial Rd.
San Carlos, CA 94070
USA

Tel: (650) 802-8292

Fax: (650) 802-8298

Email: sales@gmw.com.

User Comments: Please forward comments on this product to GMW at the above address

MOTORIZED ROTATING DRIVE SOFTWARE

MRD DRIVER.vi Front Panel

File Edit View Project Operate Tools Window Help

15pt Dialog Font

System Status

Set Position [deg] **0.0** Actual Position [deg] **0.0**

AUTO START OFF

GO TO SET POSITION

-200 -175 -150 -125 -100 -75 -50 -25 0 25 50 75 100 125 150 175 200

HOME CW HOME CCW

START MOTION CCW START MOTION CW

EMERGENCY STOP

COUNTER RESET STOP MOTION STOP PROGRAM

HOMING SETTINGS

MRD Port COM1

Velocity Value 1.0

Acceleration Value 1.0

Home Vel Value 1.0

Home Accel Value 1.0

Home Decel Value 1.0

RESET CONTROLLER

Note: These settings only change while motor is NOT in motion.

Note: These settings can change while motor is in motion or NOT in motion.

DRAWINGS

PROPRIETARY
THIS DRAWING CONTAINS CONFIDENTIAL INFORMATION
UNLESS OTHERWISE SPECIFIED. IT IS THE PROPERTY OF
GMW AND IS NOT TO BE REPRODUCED OR TRANSMITTED IN ANY
FORM OR BY ANY MEANS, ELECTRONIC OR MECHANICAL,
INCLUDING PHOTOCOPYING, RECORDING, OR BY ANY
INFORMATION STORAGE AND RETRIEVAL SYSTEM,
WITHOUT THE WRITTEN PERMISSION OF GMW, INC.

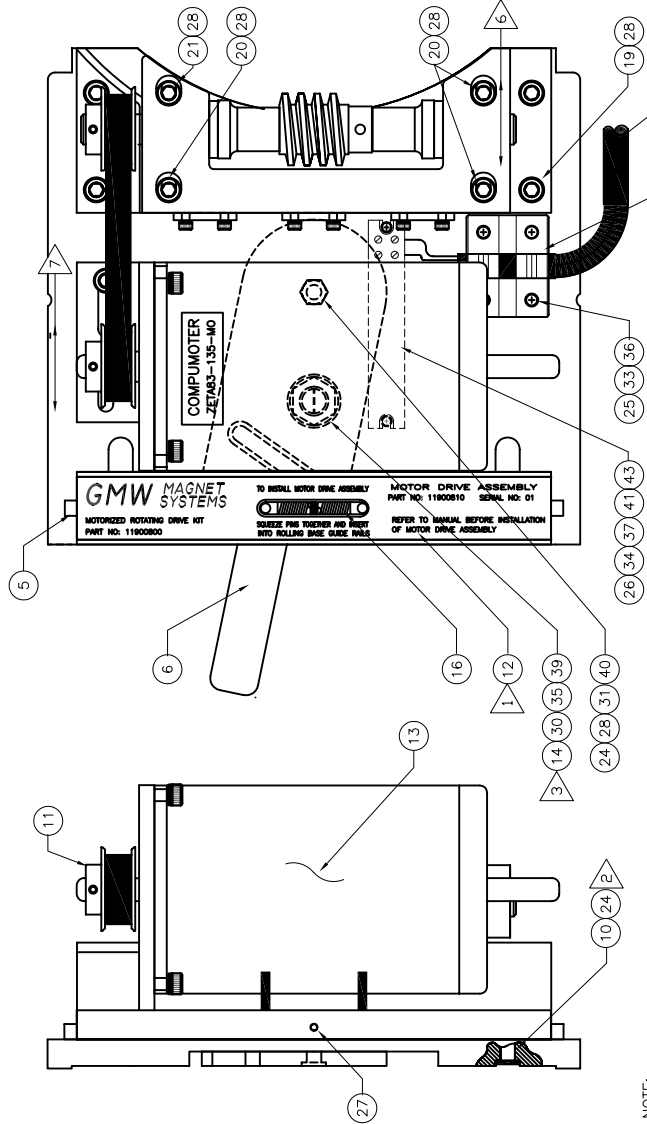
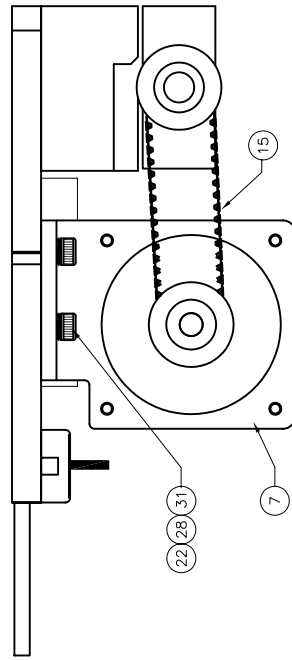

NOTE:

- 1 INSTALL LABEL [ITEM 12] ONTO LOCK HOUSING [ITEM 4].
THEN TRIM AROUND CUTOUT FOR RELEASE PINS.
- 2 APPLY LOCITITE TO THREADS ON [ITEM 24].
THEN ASSEMBLE LOCK HOUSING [ITEM 4],
USING S/S SPACER [ITEM 10].
- 3 SCREW DOWN [ITEM 14] SO THAT [ITEM 6]
IS RETAINED IN BOTH DETENTS.
LOCK IN PLACE WITH [ITEM 39].
- 4 FIT [ITEM 44] OVER EXPOSED AREA OF [ITEM 17]

- 5 SHIM WASHERS USED FOR WORM
CENTERLINE HEIGHT ADJUSTMENT.
- 6 MOVE WORM MOUNT ASSEMBLY
FORWARDS/BACKWARDS FOR WORM
MESHING ADJUSTMENT.
- 7 MOVE MOTOR MOUNT FORWARDS
OR BACKWARDS TO ADJUST BELT
TENSION.

REV	DESCRIPTION	DATE	APPROVED
A	RELEASE	07/16/08	G.DOUGLAS
B	ADD ITEMS 43,44. CHG NOTES. ITEM 13	11/29/07	G.DOUGLAS
C	CHR ITEM 11,44. ADD NOTE: 4	04/07/08	G.DOUGLAS
D	CHANGE ITEMS 11, 12, 13, 15	03/11/08	G.DOUGLAS
E	ADD ITEM 45 & NOTE 5 & 6. CHG PULLER'S VIEW	08/21/08	G.DOUGLAS

ITEM	QTY	PART NUMBER	DESCRIPTION	NOTE
45	1	17906300	LOCK HOUSING PLATE	
44	A/R		HEAT SHRINK SLEEVING, 4MM	
43	1	0.33uf	CAPACITOR	
42	2	OHS	PIPE SADDLE, COPPER 3/8" 10MM	
41	1	2412.6	TERMINAL BLOCK, 12 WAY WEIDMULLER	
40	1	DIN 934	NUT, M6, HEX HD B S/S	
39	1	DIN 934	NUT, M10, HEX HD S/S	
38	16	BN 748	WASHER, SHIM M6 X 18 X 0.5 S/S	
37	2	DIN 6797	WASHER, INT LOCK M3 X 0.4 S/S	
36	4	DIN 6797	WASHER, INT LOCK M4 X 0.5 S/S	
35	1	DIN 6797	WASHER, INT LOCK M10 X 0.5 S/S	
34	2	DIN 433	WASHER, FLAT M4 X 0.5 S/S	
33	4	DIN 433	WASHER, FLAT M4 X 0.5 S/S	
32	4	DIN 433	WASHER, FLAT M5 X 1.0 S/S	
31	3	DIN 433	WASHER, FLAT M6 X 1.6 S/S	
30	1	DIN 433	WASHER, FLAT M10 X 1.6 S/S	
29	4	BN 792	WASHER, M6 X 1.1, RIBBED SPRING/STEEL	
28	11	BN 792	WASHER, M6 X 1.2, RIBBED SPRING/STEEL	
27	1	DIN 916 A2	SHCS, M3 X 16 S/S	
26	2	DIN 7985A	SCREW, PAN HD M3 X 16 S/S	
25	4	DIN 7985A	SCREW, PAN HD M4 X 16 S/S	
24	5	BN 1206	SHCS, M6 X 16, LOW PROFILE HD #1415670	
23	4	DIN 912	SHCS, M5 X 12 S/S	
22	2	DIN 912	SHCS, M6 X 16 S/S	
21	1	DIN 912	SHCS, M6 X 30 S/S	
20	3	DIN 912	SHCS, M6 X 35 S/S	
19	4	DIN 912	SHCS, M6 X 45 S/S	
18	6M	8778	CABLE, 6 SHIELDED PAIRS, 22 AWG, BELDEN	
17	2	DIN 1481	SPRING PIN, M4 X 26L	
16	1	IHI	SPRING, COMPRESSION, 6MM DIA X 50L	
15	1	1B20EF6-55	BELT, TIMING, BERG 11" [280MM]	
14	1	SBMH-10N	BALL PLUNGER, M10 [heavy pressure]	VUER
13	1	ES33B-DFR10	MOTOR, STEPPER, ZETA, COMPUMOTOR	
12	1	109000150	LABEL, SPECIFICATION	
11	1	1P20A6W6-18	PULLEY, TIMING BELT 18 TEETH BERG	
10	5	17901202	SPACER, 9mm LONG S/S	
9	1	17901201	SPACER, 4mm LONG S/S	
8	1	17901180	SPACER, CABLE CLAMP	
7	1	17901060	MOTOR MOUNT	
6	1	17901051	DISENGAGE LEVER [For Model 3473 base]	
5	2	17901040	LOCK BAR	
4	1	17901030	LOCK HOUSING	
3	1	17901010	BASE PLATE	
2	1	11900840	STOP BLOCK ASSEMBLY	
1	1	11900850	WORM MOUNT ASSEMBLY	

REV	DESCRIPTION	DATE	APPROVED
A	RELEASE	07/16/08	G.DOUGLAS
B	ADD ITEMS 43,44. CHG NOTES. ITEM 13	11/29/07	G.DOUGLAS
C	CHR ITEM 11,44. ADD NOTE: 4	04/07/08	G.DOUGLAS
D	CHANGE ITEMS 11, 12, 13, 15	03/11/08	G.DOUGLAS
E	ADD ITEM 45 & NOTE 5 & 6. CHG PULLER'S VIEW	08/21/08	G.DOUGLAS

REV	DESCRIPTION	DATE	APPROVED
A	RELEASE	07/16/08	G.DOUGLAS
B	ADD ITEMS 43,44. CHG NOTES. ITEM 13	11/29/07	G.DOUGLAS
C	CHR ITEM 11,44. ADD NOTE: 4	04/07/08	G.DOUGLAS
D	CHANGE ITEMS 11, 12, 13, 15	03/11/08	G.DOUGLAS
E	ADD ITEM 45 & NOTE 5 & 6. CHG PULLER'S VIEW	08/21/08	G.DOUGLAS

REV	DESCRIPTION	DATE	APPROVED
A	RELEASE	07/16/08	G.DOUGLAS
B	ADD ITEMS 43,44. CHG NOTES. ITEM 13	11/29/07	G.DOUGLAS
C	CHR ITEM 11,44. ADD NOTE: 4	04/07/08	G.DOUGLAS
D	CHANGE ITEMS 11, 12, 13, 15	03/11/08	G.DOUGLAS
E	ADD ITEM 45 & NOTE 5 & 6. CHG PULLER'S VIEW	08/21/08	G.DOUGLAS

REV	DESCRIPTION	DATE	APPROVED
A	RELEASE	07/16/08	G.DOUGLAS
B	ADD ITEMS 43,44. CHG NOTES. ITEM 13	11/29/07	G.DOUGLAS
C	CHR ITEM 11,44. ADD NOTE: 4	04/07/08	G.DOUGLAS
D	CHANGE ITEMS 11, 12, 13, 15	03/11/08	G.DOUGLAS
E	ADD ITEM 45 & NOTE 5 & 6. CHG PULLER'S VIEW	08/21/08	G.DOUGLAS

REV	DESCRIPTION	DATE	APPROVED
A	RELEASE	07/16/08	G.DOUGLAS
B	ADD ITEMS 43,44. CHG NOTES. ITEM 13	11/29/07	G.DOUGLAS
C	CHR ITEM 11,44. ADD NOTE: 4	04/07/08	G.DOUGLAS
D	CHANGE ITEMS 11, 12, 13, 15	03/11/08	G.DOUGLAS
E	ADD ITEM 45 & NOTE 5 & 6. CHG PULLER'S VIEW	08/21/08	G.DOUGLAS

REV	DESCRIPTION	DATE	APPROVED
A	RELEASE	07/16/08	G.DOUGLAS
B	ADD ITEMS 43,44. CHG NOTES. ITEM 13	11/29/07	G.DOUGLAS
C	CHR ITEM 11,44. ADD NOTE: 4	04/07/08	G.DOUGLAS
D	CHANGE ITEMS 11, 12, 13, 15	03/11/08	G.DOUGLAS
E	ADD ITEM 45 & NOTE 5 & 6. CHG PULLER'S VIEW	08/21/08	G.DOUGLAS

REV	DESCRIPTION	DATE	APPROVED
A	RELEASE	07/16/08	G.DOUGLAS
B	ADD ITEMS 43,44. CHG NOTES. ITEM 13	11/29/07	G.DOUGLAS
C	CHR ITEM 11,44. ADD NOTE: 4	04/07/08	G.DOUGLAS
D	CHANGE ITEMS 11, 12, 13, 15	03/11/08	G.DOUGLAS
E	ADD ITEM 45 & NOTE 5 & 6. CHG PULLER'S VIEW	08/21/08	G.DOUGLAS

REV	DESCRIPTION	DATE	APPROVED
A	RELEASE	07/16/08	G.DOUGLAS
B	ADD ITEMS 43,44. CHG NOTES. ITEM 13	11/29/07	G.DOUGLAS
C	CHR ITEM 11,44. ADD NOTE: 4	04/07/08	G.DOUGLAS
D	CHANGE ITEMS 11, 12, 13, 15	03/11/08	G.DOUGLAS
E	ADD ITEM 45 & NOTE 5 & 6. CHG PULLER'S VIEW	08/21/08	G.DOUGLAS

REV	DESCRIPTION	DATE	APPROVED
A	RELEASE	07/16/08	G.DOUGLAS
B	ADD ITEMS 43,44. CHG NOTES. ITEM 13	11/29/07	G.DOUGLAS
C	CHR ITEM 11,44. ADD NOTE: 4	04/07/08	G.DOUGLAS
D	CHANGE ITEMS 11, 12, 13, 15	03/11/08	G.DOUGLAS
E	ADD ITEM 45 & NOTE 5 & 6. CHG PULLER'S VIEW	08/21/08	G.DOUGLAS

REV	DESCRIPTION	DATE	APPROVED
A	RELEASE	07/16/08	G.DOUGLAS
B	ADD ITEMS 43,44. CHG NOTES. ITEM 13	11/29/07	G.DOUGLAS
C	CHR ITEM 11,44. ADD NOTE: 4	04/07/08	G.DOUGLAS
D	CHANGE ITEMS 11, 12, 13, 15	03/11/08	G.DOUGLAS
E	ADD ITEM 45 & NOTE 5 & 6. CHG PULLER'S VIEW	08/21/08	G.DOUGLAS

REV	DESCRIPTION	DATE	APPROVED
A	RELEASE	07/16/08	G.DOUGLAS
B	ADD ITEMS 43,44. CHG NOTES. ITEM 13	11/29/07	G.DOUGLAS
C	CHR ITEM 11,44. ADD NOTE: 4	04/07/08	G.DOUGLAS
D	CHANGE ITEMS 11, 12, 13, 15	03/11/08	G.DOUGLAS
E	ADD ITEM 45 & NOTE 5 & 6. CHG PULLER'S VIEW	08/21/08	G.DOUGLAS

REV	DESCRIPTION	DATE	APPROVED
A	RELEASE	07/16/08	G.DOUGLAS
B	ADD ITEMS 43,44. CHG NOTES. ITEM 13	11/29/07	G.DOUGLAS
C	CHR ITEM 11,44. ADD NOTE: 4	04/07/08	G.DOUGLAS
D	CHANGE ITEMS 11, 12, 13, 15	03/11/08	G.DOUGLAS
E	ADD ITEM 45 & NOTE 5 & 6. CHG PULLER'S VIEW	08/21/08	G.DOUGLAS

REV	DESCRIPTION	DATE	APPROVED
A	RELEASE	07/16/08	G.DOUGLAS
B	ADD ITEMS 43,44. CHG NOTES. ITEM 13	11/29/07	G.DOUGLAS
C	CHR ITEM 11,44. ADD NOTE: 4	04/07/08	G.DOUGLAS
D	CHANGE ITEMS 11, 12, 13, 15	03/11/08	G.DOUGLAS
E	ADD ITEM 45 & NOTE 5 & 6. CHG PULLER'S VIEW	08/21/08	G.DOUGLAS

REV	DESCRIPTION	DATE	APPROVED
A	RELEASE	07/16/08	G.DOUGLAS
B	ADD ITEMS 43,44. CHG NOTES. ITEM 13	11/29/07	G.DOUGLAS
C	CHR ITEM 11,44. ADD NOTE: 4	04/07/08	G.DOUGLAS
D	CHANGE ITEMS 11, 12, 13, 15	03/11/08	G.DOUGLAS
E	ADD ITEM 45 & NOTE 5 & 6. CHG PULLER'S VIEW	08/21/08	G.DOUGLAS

REV	DESCRIPTION	DATE	APPROVED
A	RELEASE	07/16/08	G.DOUGLAS
B	ADD ITEMS 43,44. CHG NOTES. ITEM 13	11/29/07	G.DOUGLAS
C	CHR ITEM 11,44. ADD NOTE: 4	04/07/08	G.DOUGLAS
D	CHANGE ITEMS 11, 12, 13, 15	03/11/08	G.DOUGLAS
E	ADD ITEM 45 & NOTE 5 & 6. CHG PULLER'S VIEW	08/21/08	G.DOUGLAS

REV	DESCRIPTION	DATE	APPROVED
A	RELEASE	07/16/08	G.DOUGLAS
B	ADD ITEMS 43,44. CHG NOTES. ITEM 13	11/29/07	G.DOUGLAS
C	CHR ITEM 11,44. ADD NOTE: 4	04/07/08	G.DOUGLAS
D	CHANGE ITEMS 11, 12, 13, 15	03/11/08	G.DOUGLAS
E	ADD ITEM 45 & NOTE 5 & 6. CHG PULLER'S VIEW	08/21/08	G.DOUGLAS

REV	DESCRIPTION	DATE	APPROVED
A	RELEASE	07/16/08	G.DOUGLAS
B	ADD ITEMS 43,44. CHG NOTES. ITEM 13	11/29/07	G.DOUGLAS
C	CHR ITEM 11,44. ADD NOTE: 4	04/07/08	G.DOUGLAS
D	CHANGE ITEMS 11, 12, 13, 15	03/11/08	G.DOUGLAS
E	ADD ITEM 45 & NOTE 5 & 6. CHG PULLER'S VIEW	08/21/08	G.DOUGLAS

REV	DESCRIPTION	DATE	APPROVED
A	RELEASE	07/16/08	G.DOUGLAS
B	ADD ITEMS 43,44. CHG NOTES. ITEM 13	11/29/07	G.DOUGLAS
C	CHR ITEM 11,44. ADD NOTE: 4	04/07/08	G.DOUGLAS
D	CHANGE ITEMS 11, 12, 13, 15	03/11/08	G.DOUGLAS
E	ADD ITEM 45 & NOTE 5 & 6. CHG PULLER'S VIEW	08/21/08	G.DOUGLAS

REV	DESCRIPTION	DATE	APPROVED
A	RELEASE	07/16/08	G.DOUGLAS
B	ADD ITEMS 43,44. CHG NOTES. ITEM 13	11/29/07	G.DOUGLAS
C	CHR ITEM 11,44. ADD NOTE: 4	04/07/08	G.DOUGLAS
D	CHANGE ITEMS 11, 12, 13, 15	03/11/08	G.DOUGLAS
E	ADD ITEM 45 & NOTE 5 & 6. CHG PULLER'S VIEW	08/21/08	G.DOUGLAS

REV	DESCRIPTION	DATE	APPROVED
A	RELEASE	07/16/08	G.DOUGLAS
B	ADD ITEMS 43,44. CHG NOTES. ITEM 13	11/29/07	G.DOUGLAS
C	CHR ITEM 11,44. ADD NOTE: 4	04/07/08	G.DOUGLAS
D	CHANGE ITEMS 11, 12, 13, 15	03/11/08	G.DOUGLAS
E	ADD ITEM 45 & NOTE 5 & 6. CHG PULLER'S VIEW	08/21/08	G.DOUGLAS

REV	DESCRIPTION	DATE	APPROVED
A	RELEASE	07/16/08	G.DOUGLAS
B	ADD ITEMS 43,44. CHG NOTES. ITEM 13	11/29/07	G.DOUGLAS
C	CHR ITEM 11,44. ADD NOTE: 4	04/07/08	G.DOUGLAS
D	CHANGE ITEMS 11, 12, 13, 15	03/11/08	G.DOUGLAS
E	ADD ITEM 45 & NOTE 5 & 6. CHG PULLER'S VIEW	08/21/08	G.DOUGLAS

REV	DESCRIPTION	DATE	APPROVED
A	RELEASE	07/16/08	G.DOUGLAS
B	ADD ITEMS 43,44. CHG NOTES. ITEM 13	11/29/07	G.DOUGLAS
C	CHR ITEM 11,44. ADD NOTE: 4	04/07/08	G.DOUGLAS
D	CHANGE ITEMS 11, 12, 13, 15	03/11/08	G.DOUGLAS
E	ADD ITEM 45 & NOTE 5 & 6. CHG PULLER'S VIEW	08/21/08	G.DOUGLAS

REV	DESCRIPTION	DATE	APPROVED
A	RELEASE	07/16/08	G.DOUGLAS
B	ADD ITEMS 43,44. CHG NOTES. ITEM 13	11/29/07	G.DOUGLAS
C	CHR ITEM 11,44. ADD NOTE: 4	04/07/08	G.DOUGLAS
D	CHANGE ITEMS 11, 12, 13, 15	03/11/08	G.DOUGLAS
E	ADD ITEM 45 & NOTE 5 & 6. CHG PULLER'S VIEW	08/21/08	G.DOUGLAS

REV	DESCRIPTION	DATE	APPROVED
A	RELEASE	07/16/08	G.DOUGLAS
B	ADD ITEMS 43,44. CHG NOTES. ITEM 13		

PROPRIETARY
THIS DRAWING CONTAINS CONFIDENTIAL INFORMATION.
REPRODUCTION OR DISSEMINATION OF THIS DRAWING
WITHOUT THE EXPRESS WRITTEN PERMISSION OF
GMW INC. IS STRICTLY PROHIBITED.

LONG DISENGAGE LEVEL
(END TO SCALE LENGTH)

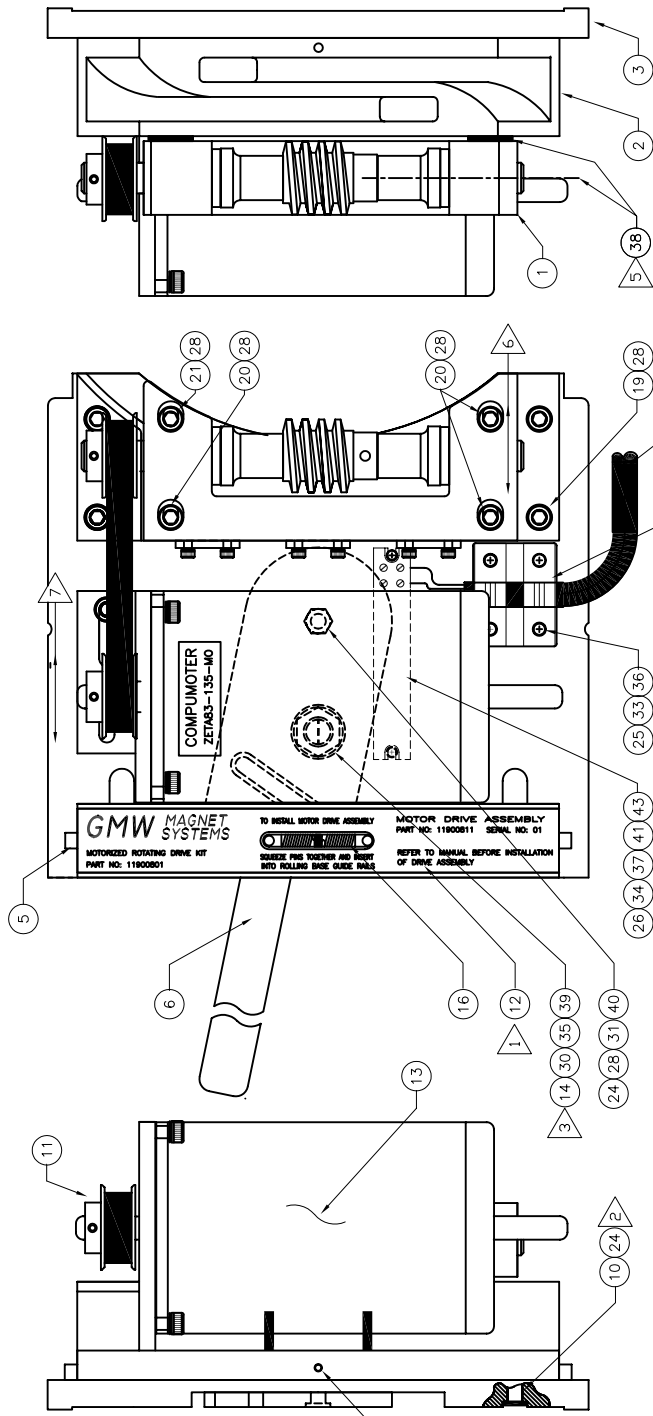
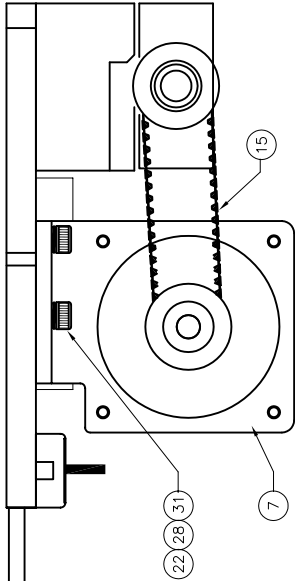

- NOTE:
- 1 INSTALL LABEL [ITEM 12] ONTO LOCK HOUSING [ITEM 4].
THEN TRIM AROUND CUTOUT FOR RELEASE PINS.
 - 2 APPLY LOCTITE TO THREADS ON [ITEM 24].
THEN ASSEMBLE LOCK HOUSING [ITEM 4].
USING S/S SPACER [ITEM 10].
 - 3 SCREW DOWN [ITEM 14] SO THAT [ITEM 6]
IS RETAINED IN BOTH DETENTS.
LOCK IN PLACE WITH [ITEM 39].
 - 4 FIT [ITEM 44] OVER EXPOSED AREA OF [ITEM 17]

- 5 SHIM WASHERS USED FOR WORM
CENTERLINE HEIGHT ADJUSTMENT.
- 6 MOVE WORM MOUNT ASSEMBLY
FORWARDS/BACKWARDS FOR WORM
MESHING ADJUSTMENT.
- 7 MOVE MOTOR MOUNT FORWARDS
OR BACKWARDS TO ADJUST BELT
TENSION.

REV	RELEASE	DESCRIPTION	DRAWN	DATE	APPROVED
A	07/16/98			07/16/98	G.DOUGLAS
B	04/09/98	CHG ITEM 11, 44, ADD NOTE: 4		04/09/98	G.DOUGLAS
C	04/07/98	CHG ITEM 11, 44, ADD NOTE: 4		04/07/98	G.DOUGLAS
D	03/11/98	CHANGE ITEMS 11, 12, 13, 15		03/11/98	G.DOUGLAS
E	08/21/98	ADD ITEM 45 & NOTE 5 & 6 CHG PULLEYS VIEW		08/21/98	G.DOUGLAS

ITEM	QTY	PART NUMBER	DESCRIPTION
45	1	17906300	LOCK HOUSING PLATE
44 A/R			HEAT SHRINK SLEEVING, 4MM
43	1	10.33JF	CAPACITOR
42	2	2 OHS	PIPE SADDLE, COPPER 3/8" 10MM
41	1	12412.6	TERMINAL BLOCK, 12 WAY WEIDMULLER
40	1	DIN 934	NUT, M6, HEX HD B S/S
39	1	DIN 934	NUT, M10, HEX HD S/S
38	16	BN 748	WASHER, SHIM M6 X 18 X 0.5 S/S
37	2	DIN 6797	WASHER, INT LOCK M4 X 0.4 S/S
36	4	DIN 6797	WASHER, INT LOCK M4 X 0.5 S/S
35	1	DIN 6797	WASHER, INT LOCK M10 X 0.5 S/S
34	2	DIN 433	WASHER, FLAT M3 X 0.5 S/S
33	4	DIN 433	WASHER, FLAT M4 X 0.5 S/S
32	4	DIN 433	WASHER, FLAT M5 X 1.0 S/S
31	3	DIN 433	WASHER, FLAT M6 X 1.6 S/S
30	1	DIN 433	WASHER, FLAT M10 X 1.6 S/S
29	4	BN792	WASHER, M6 X 1.2, RIBBED SPRING/STEEL
28	11	BN792	SHCS M3 X 16 S/S
27	1	DIN 916 A2	SCWS M6 X 16 S/S
26	2	DIN 7985A	SCREW, PAN HD M3 X 16 S/S
25	4	DIN 7985A	SCREW, PAN HD M4 X 16 S/S
24	5	BN 1206	SHCS, M6 X 16, LOW PROFILE HD #1415670
23	4	DIN 912	SHCS M5 X 12 S/S
22	2	DIN 912	SCWS M6 X 16 S/S
21	1	DIN 912	SHCS, M6 X 30 S/S
20	3	DIN 912	SHCS, M6 X 35 S/S
19	4	DIN 912	SHCS, M6 X 45 S/S
18	6M	8778	CABLE, 6 SHIELDED PAIRS, 22 AWG, BELDEN
17	3	DIN 1481	SPRING PIN, M4 X 26L
16	1	IHI	SPRING, COMPRESSION, 6MM DIA X 50L
15	1	TB20F6-55	BELT, TIMING, BERG 11" [280MM]
14	1	SBMH-10N	BALL PLUNGER, M10 [heavy pressure] VIJER
13	1	ES35B-DR10	MOTOR, STEPPER, ZETA, COMPUTOER
12	1	10900151	LABEL, SPECIFICATION
11	1	TP20A6W6-18	PULLEY, TIMING BELT 18 TEETH BERG
10	5	17901202	SPACER, 9MM LONG S/S
9	1	17901201	SPACER, 4MM LONG S/S
8	1	17901180	SPACER, CABLE CLAMP
7	1	17901080	MOTOR MOUNT
6	1	17901052	DISENGAGE LEVER [For Model 3474 base]
5	2	17901040	LOCK BAR
4	1	17901030	LOCK HOUSING
3	1	17901010	BASE PLATE
2	1	11900840	STOP BLOCK ASSEMBLY
1	1	11900850	WORM MOUNT ASSEMBLY

PARTS LIST	
DATE: 08/07/98	DO NOT SCALE
DRAWN: G.DOUGLAS	FROM DRAWING
CHKD: G.DOUGLAS	UNLESS OTHERWISE SPECIFIED
ENGR: G.DOUGLAS	
DATE: 08/07/98	
SCALE: 1:1	
WGT: KG	
SHEET: 1	OF: 1
TITLE: MOTORIZED ROTATING DRIVE	
DESCRIPTION: MOTOR DRIVE ASSEMBLY 3474	
REV: A1	11900811
DATE: 08/07/98	
REV: A1	11900811

REV	DATE	DESCRIPTION
A1	11900811	MOTORIZED ROTATING DRIVE MOTOR DRIVE ASSEMBLY 3474

PROPRIETARY
 THIS DRAWING CONTAINS CONFIDENTIAL INFORMATION
 PROPRIETARY TO GAW INC. IT MUST NOT BE
 REPRODUCED OR DISCLOSED TO OTHERS OR USED IN ANY
 OTHER WAY, IN WHOLE OR IN PART EXCEPT AS AUTHORIZED
 IN WRITING BY GAW INC.

BOTTOM VIEW

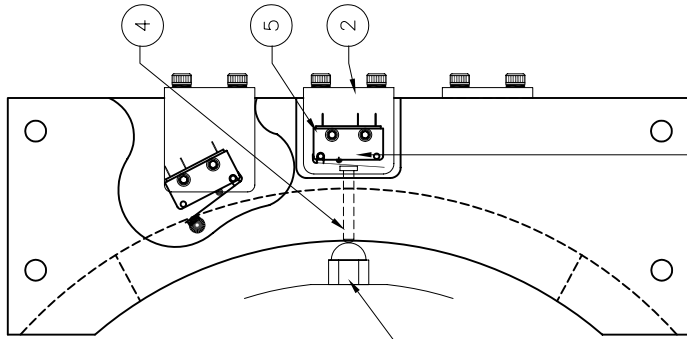

REAR VIEW

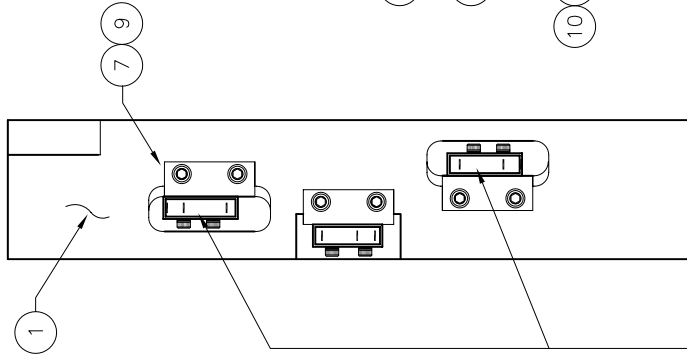

TOP VIEW

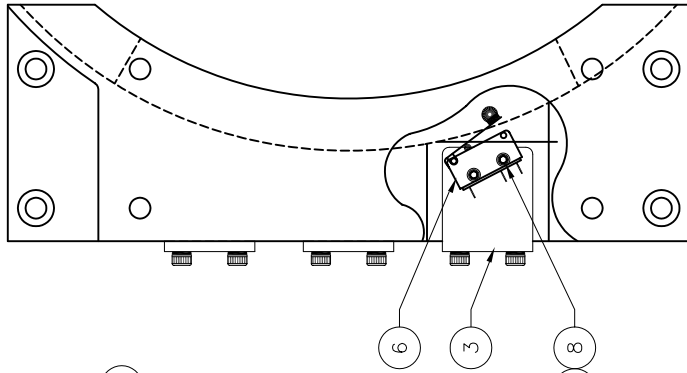

MAXIMUM TRAVEL LIMIT MICROSWITCHES, NC CONTACT.
 MICROSWITCH OPENS WHEN MAX TRAVEL POSITION IS REACHED.

HOMING MICROSWITCH NO CONTACT. MICROSWITCH CLOSES
 CONTACT WHEN HOMING POSITION 0.0 DEG IS REACHED.

ZERO BUTTON [HOMING POSITION 0.0 DEG] MOUNTED ON SPOOL ASSEMBLY
 SEE DWG NO: 119000820 FOR MORE DETAILS.

ITEM	QTY	PART NUMBER	DESCRIPTION	NOTE
10	6	BN 752	WASHER, LOCK SP/S M2 X 0.5 SP/S	
9	6	BN 792	WASHER, LOCK SP/S M3 X 0.9 SP/S	
8	6	DIN 912	BOLT, SHCS M2 X 10 S/S	
7	6	DIN 912	BOLT, SHCS M3 X 10 S/S	
6	2	V4NT7	MICROSWITCH, BURGESS	
5	1	V4NT9	MICROSWITCH, BURGESS	
4	1	17901170	SHAFT, ZERO MICROSWITCH	
3	2	17901160	BRACKET, LIMIT MICROSWITCH	
2	1	17901150	BRACKET, ZERO MICROSWITCH	
1	1	17901070	STOP BLOCK	

PARTS LIST

DATE	DATE	DATE	DATE	DATE	DATE
DRAWN G.DOUGLAS	05/02/97	CHECK G.DOUGLAS	05/02/97	ENGINEERING	
DO NOT SCALE FROM DRAWING DIMENSIONS & TOLERANCES (UNLESS OTHERWISE SPECIFIED)					
LINEAR	INCHES	mm.			
X.XXX	±.001	±0.03			
X.XX	±.01	±0.1			
X.X	±.05	±0.3			
X	±.06	±1			
DEC.	±.5	±0.5			
FINISH	63	1.6			
THIRD ANGLE PROJECTION					
11900810	SYSTEM				
NEXT ASSY					
SOFTWARE					
AUTOCAD 2000					

GMW 955 Industrial Rd, San Carlos, CA 94070 Tel: (650)802-8292. Fax: (650)802-8298.	
TITLE	MOTORIZED.ROT.DRIVE STOP BLOCK ASSY
SIZE	A2
DRAWING NO.	11900840
REV	B

REV	DESCRIPTION	DRAFT	DATE	APPROVED
A	RELEASE		07/07/97	G.DOUGLAS
B	UPDATE VIEW OF MICROSWITCH CUTOUTS		03/10/08	G.DOUGLAS

REVISIONS

1

D

C

H

B

A

1

2

3

4

D

C

H

B

A

1

2

3

4

D

C

H

B

A

1

2

3

4

D

C

H

B

A

1

2

3

4

D

C

H

B

A

1

2

3

4

D

C

H

B

A

1

2

3

4

D

C

H

B

A

1

2

3

4

D

C

H

B

A

1

2

3

4

D

C

H

B

A

1

2

3

4

D

C

H

B

A

1

2

3

4

D

C

H

B

A

1

2

3

4

D

C

H

B

A

1

2

3

4

D

C

H

B

A

1

2

3

4

D

C

H

B

A

1

2

3

4

D

C

H

B

A

1

2

3

4

D

C

H

B

A

1

2

3

4

D

C

H

B

A

1

2

3

4

D

C

H

B

A

1

2

3

4

D

C

H

B

A

1

2

3

4

D

C

H

B

A

1

2

3

4

D

C

H

B

A

1

2

3

4

D

C

H

B

A

1

2

3

4

D

C

H

B

A

1

2

3

4

D

C

H

B

A

1

2

3

4

D

C

H

B

A

1

2

3

4

D

C

H

B

A

1

2

3

4

D

C

H

B

A

1

2

3

4

D

C

H

B

A

1

2

3

4

D

C

H

B

A

1

2

3

4

D

C

H

B

A</

PROPRIETARY
 THIS DRAWING CONTAINS CONFIDENTIAL INFORMATION
 PROPRIETARY TO GAW INC. IT MUST NOT BE
 REPRODUCED OR DISCLOSED TO OTHERS OR USED IN ANY
 OTHER WAY, IN WHOLE OR IN PART EXCEPT AS AUTHORIZED
 IN WRITING BY GAW INC.

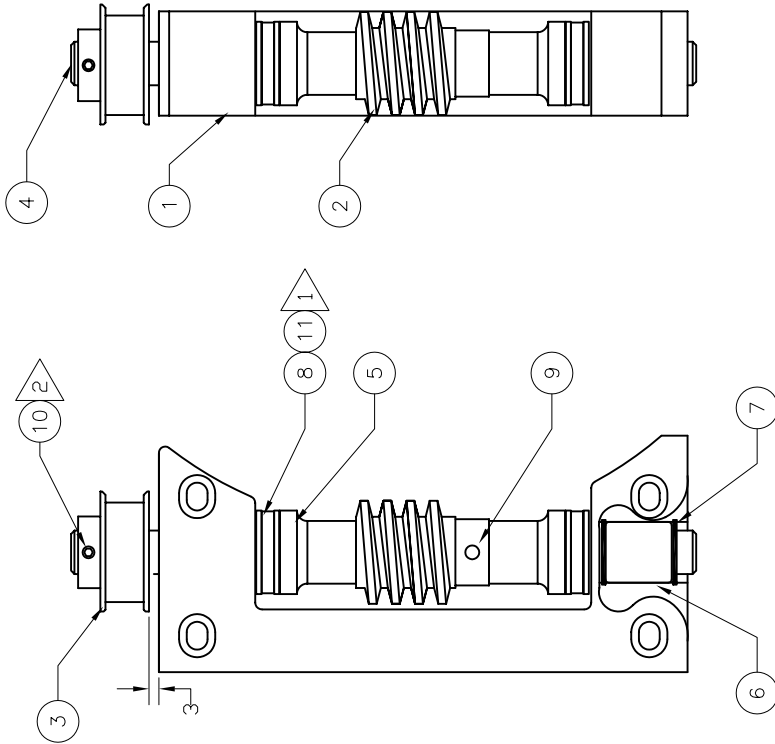

FRONT VIEW

TOP VIEW

- NOTE:
- 1 USE ITEM 11 TO PACK WORM DRIVE ASSEMBLY TO REDUCE SHAFT AXIAL MOVEMENT TO MINIMUM POSSIBLE. SHAFT MUST ROTATE FREELY.
 - 2 ENSURE SETSCREW FITS ONTO SHAFT FLAT SURFACE.

REV	DESCRIPTION	DRAFT	DATE	APPROVED
A	RELEASE		07/07/97	G.DOUGLAS
B	ADD ITEM 11 AND NOTE: 1, CHG ITEM 3		11/27/97	G.DOUGLAS
C	CHG ITEM 3		04/08/98	G.DOUGLAS
D	CHANGE ITEM 3,7,8		03/07/08	G.DOUGLAS
E	CHANGE ITEM 10 & PULLEY/BEARING VIEW, ADD NOTE 2		08/21/08	G.DOUGLAS

ITEM	QTY	PART NUMBER	DESCRIPTION	NOTE
11A/R	1	BN 748	SHIM WASHER, 14 X 26 X 0.1MM THICK	
10	1		SETSCREW 8-32 x 1/4" UNC	
9	1	DIN 1481	PIN, SPRING M4 X 18L, SP/S	
8	2	B5-6-SS	BEARING, THRUST 0.5" SHAFT, BERG	
7	4	O9-71	BEARING RETAINING RING, BERG	
6	2	S99NH2-BNT624	BEARING, NEEDLE ROLLER, SDP	
5	2	17901190	SPACER, WORM	
4	1	12900060	WORM SHAFT	
3	1	TP20A8W6-18	PULLEY, 18 TEETH [for 0.5" shaft] BERG	
2	1	12900030	WORM	
1	1	17901080	WORM MOUNT	

PARTS LIST		DO NOT SCALE FROM DRAWING DIMENSIONS & TOLERANCES (UNLESS OTHERWISE SPECIFIED)		TITLE	
DRAWN	DATE	LINEAR	INCHES	MOTORIZED.ROT.DRIVE	
G.DOUGLAS	05/03/97	X.XXX	±.001	WORM MOUNT ASSY	
CHECK	DATE	X.XX	±.01	DRAWING NO. A2 11900850	
ENGINEERING	DATE	X.X	±.05	REV E	
		X	±.08	SCALE 1:1 WT kg SHEET 1 OF 1	
		DEC.	±.5		
11800810		FINISH	63		
NEXT ASSY	SYSTEM	THIRD ANGLE PROJECTION			
SOFTWARE	AUTOCAD 2000				

GMW
 955 Industrial Rd, San Carlos, CA 94070
 Tel: (650)802-8292. Fax: (650)802-8298.

PROPRIETARY
 THIS DRAWING CONTAINS CONFIDENTIAL INFORMATION.
 REPRODUCTION OR DISSEMINATION TO OTHERS OR USE IN ANY
 MANNER WITHOUT THE EXPRESS WRITTEN AUTHORIZATION OF
 GM DOUGLAS IS STRICTLY PROHIBITED.

TOP VIEW

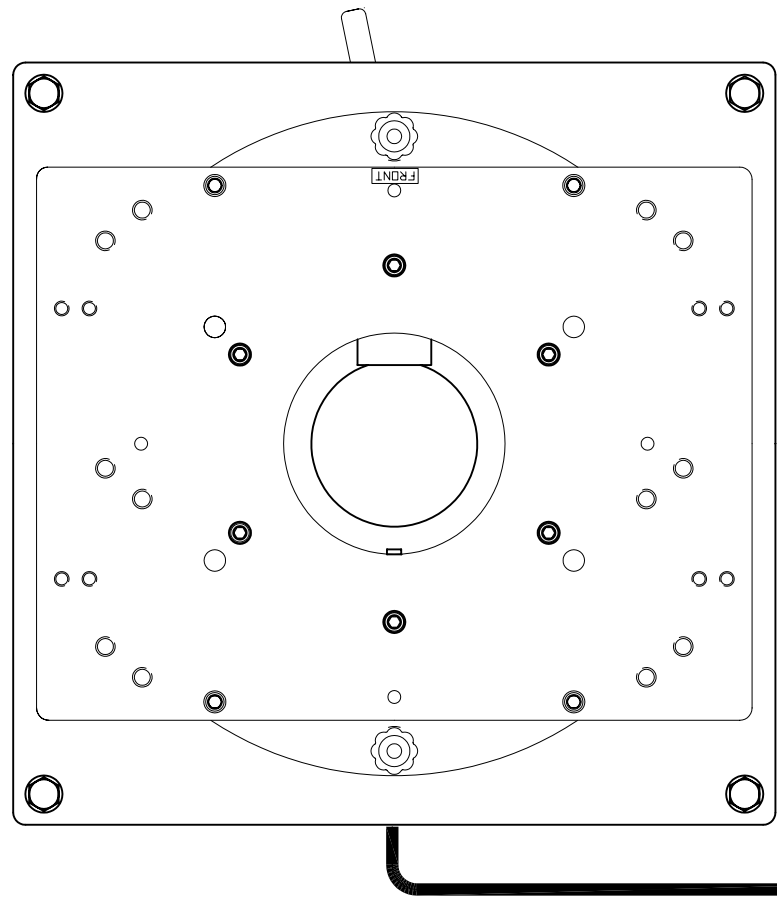

MOTOR AND LIMIT SWITCH CABLE PART NO 16900400

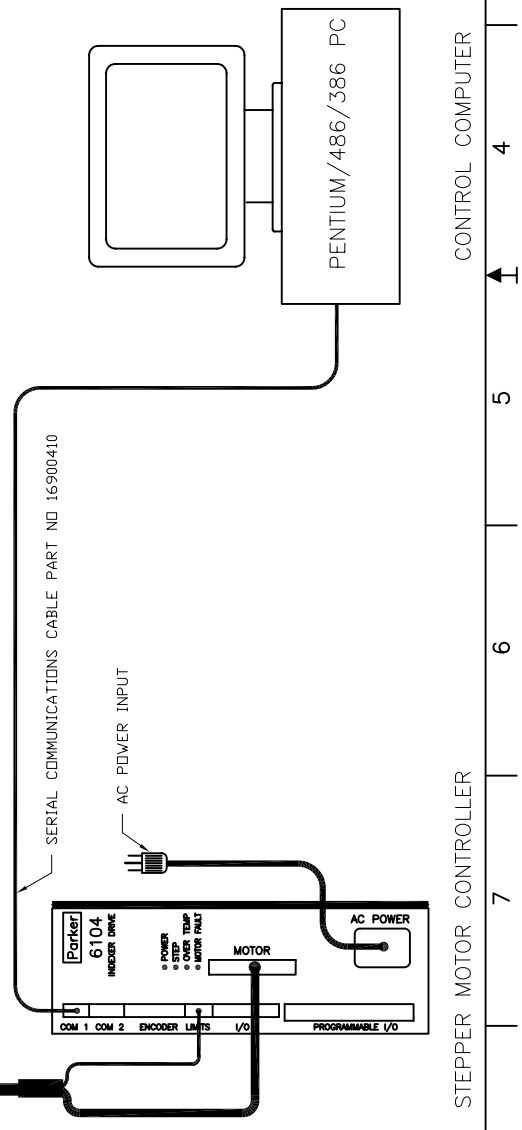

STEPPER MOTOR CONTROLLER

CONTROL COMPUTER

NOTE

1. THIS DRAWING SHOWS 3473/3472/5201 SYSTEM. WIRING IDENTICAL FOR 3474 SYSTEM.
2. SEE DRAWING NO: 13900350 FOR DETAILED ELECTRICAL WIRING.
3. MICROSWITCHES FUNCTIONS
 HOMING: ROTATES DRIVE TO 0.0 DEG POSITION
 LIMITS: STOPS ROTATION AT +/-200 DEG POSITION.
 MICROSWITCHES MOUNTED ON STOP BLOCK ASSEMBLY SEE DWG NO: 11900840 FOR DETAILS.

REVISIONS			
REV	DESCRIPTION	DRAWN	DATE
A	RELEASE	G DOUGLAS	07/17/98
B	1 INCR SIZE OF TRANSITION PLATE, ADD 5403EG MTG HOLES	G DOUGLAS	07/29/03

ITEM	QTY	PART NUMBER	DESCRIPTION	NOTE
PARTS LIST				
DO NOT SCALE FROM DRAWING UNLESS OTHERWISE SPECIFIED				
DATE	07/17/98	DATE	07/17/98	APPROVED
DRAWN	G DOUGLAS	DATE	07/17/98	G DOUGLAS
ENGINEERING		DATE		
TITLE				
UNSCR	INCHES	UNITS	UNITS	
X	3/16	3/16	3/16	
Y	3/16	3/16	3/16	
Z	3/16	3/16	3/16	
SIZE				
ENC	1/2	1/2	1/2	
THIRD ANGLE PROJECTION				
DRYK ASSY	SYSTEM	THIRD ANGLE PROJECTION	SIZE	DRAWING NO.
SOFTWARE	AUTOCAD 2000	SCALE	1:2	WT KG
				SHEET 1 OF 1

GMW

955 Industrial Rd, San Carlos, CA 94070
 Tel: (650)802-8292, Fax: (650)802-8298.

MOTORIZED ROT DRIVE ELECTRICAL ASSY

A111901020

PROPRIETARY
 THIS DRAWING CONTAINS CONFIDENTIAL INFORMATION
 PROPRIETARY TO GMW INC. IT MUST NOT BE
 REPRODUCED OR DISCLOSED TO OTHERS OR USED IN ANY
 OTHER WAY, IN WHOLE OR IN PART EXCEPT AS AUTHORIZED
 IN WRITING BY GMW INC.

NOTE: ROTATING BASE SHOWN AT THE 0 DEG POSITION

RECOMMENDED ROUTING
 OF CABLES & HOSES

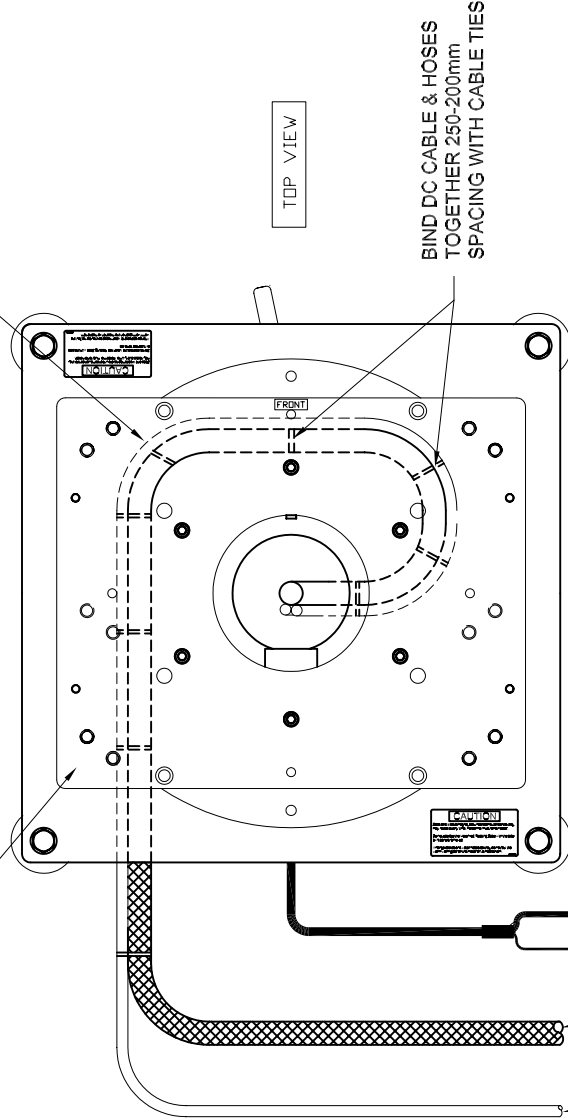

TOP VIEW

BIND DC CABLE & HOSES
 TOGETHER 250-200mm
 SPACING WITH CABLE TIES

STEPPER MOTOR ELECTRICAL CONNECTIONS

DC CURRENT & INTERLOCK CABLE

COOLING WATER HOSES

CABLES & HOSES TO ELECTROMAGNET

SIDE VIEW

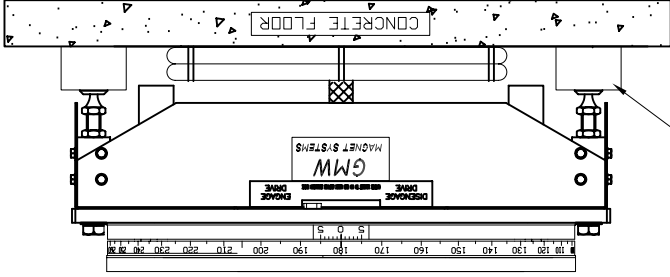
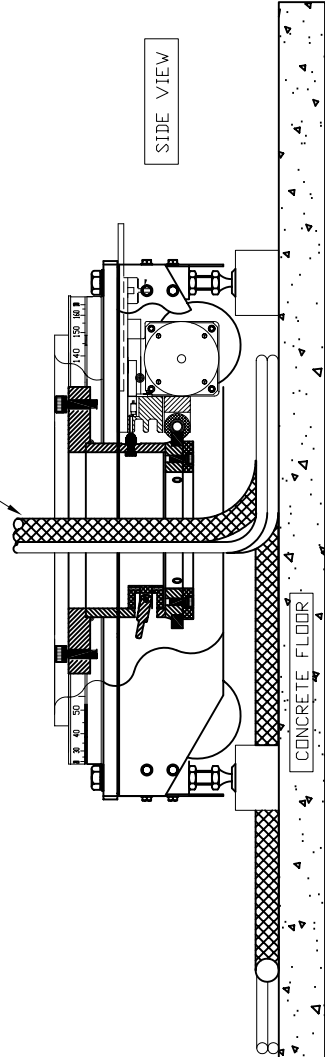

FRONT VIEW

BASE FLOOR SPACER
 PART NO: 17906330

REVISIONS		DESCRIPTION	DRAFT	DATE	APPROVED
REV	A	RELEASE		08/21/08	G. DOUGLAS

ITEM	QTY	PART NUMBER	DESCRIPTION	NOTE
PARTS LIST				
DO NOT SCALE FROM DRAWING DIMENSIONS & TOLERANCES (UNLESS OTHERWISE SPECIFIED)				
DRAWN	G. DOUGLAS	DATE	08/21/08	
CHECK		DATE		
ENGINEERING		DATE		
NEXT ASSY		SYSTEM	SOFTWARE	AUTOCAD 2000
TITLE		MOTORIZED ROTATING DRIVE MODEL: 3473 INSTALLATION		
DRAWING NO.		A2 11902620		
SCALE		1:4		
WT kg		1		
SHEET		1 OF 1		

GMW
 955 Industrial Rd, San Carlos, CA 94070
 Tel: (650)802-8292. Fax: (650)802-8298.

REV A

PROPRIETARY
 THIS DRAWING CONTAINS CONFIDENTIAL INFORMATION
 PROPRIETARY TO GMM INC. IT MUST NOT BE
 REPRODUCED OR DISCLOSED TO OTHERS OR USED IN ANY
 OTHER WAY, IN WHOLE OR IN PART EXCEPT AS AUTHORIZED
 IN WRITING BY GMM INC.

NOTE: ROTATING BASE SHOWN AT THE 0 DEG POSITION

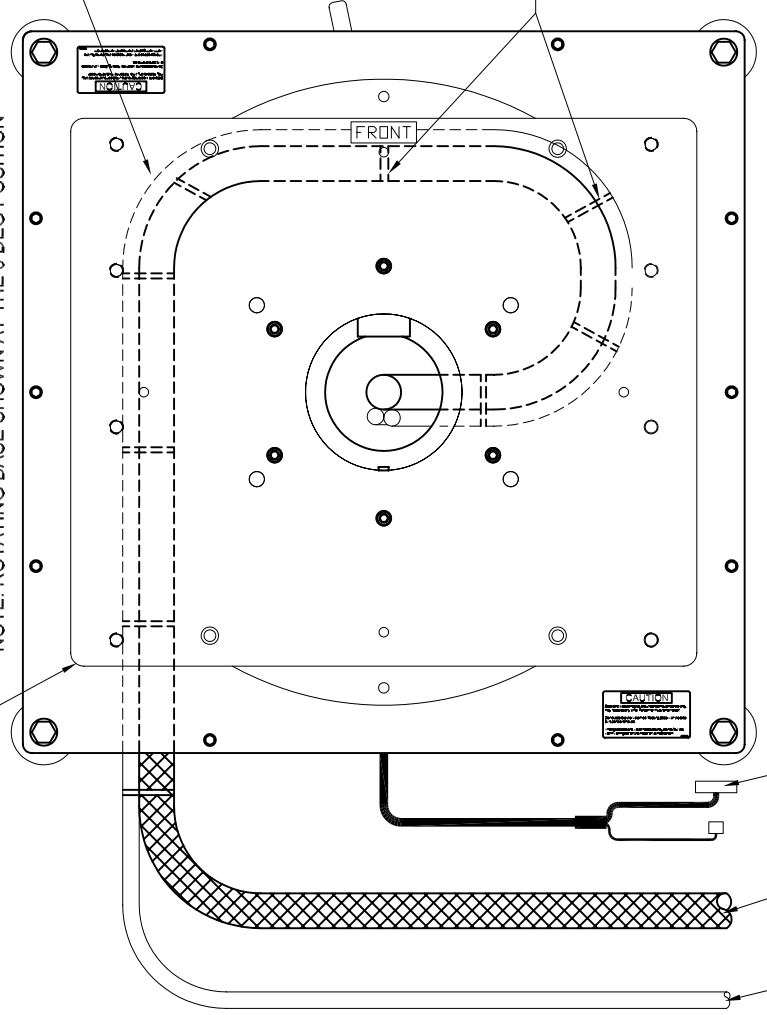

TOP VIEW

RECOMMENDED ROUTING
 OF CABLES & HOSES

BIND DC CABLE & HOSES
 TOGETHER 200-250mm
 SPACING WITH CABLE TIES

STEPPER MOTOR ELECTRICAL CONNECTIONS

DC CURRENT & INTERLOCK CABLE

COOLING WATER HOSES

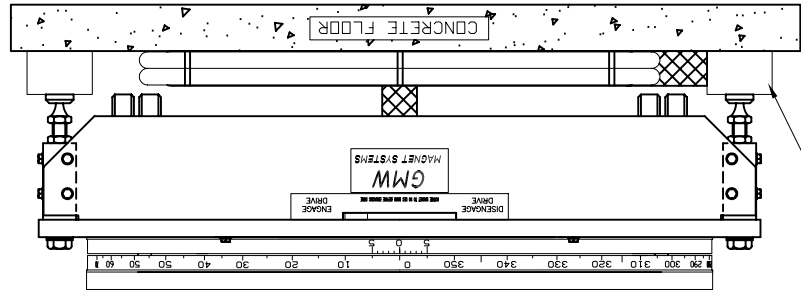

FRONT VIEW

BASE FLOOR SPACER
 PART NO: 17906330

CABLES & HOSES TO ELECTROMAGNET

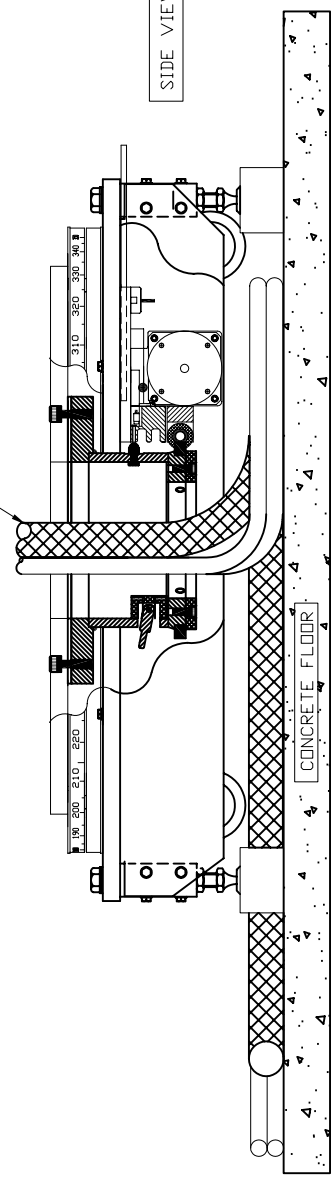

SIDE VIEW

REVISIONS			
REV	DESCRIPTION	DRAFT	DATE
A	RELEASE		08/18/08
			G.DOUGLAS

ITEM	QTY	PART NUMBER	DESCRIPTION	NOTE
PARTS LIST				
DO NOT SCALE FROM DRAWING DIMENSIONS & TOLERANCES (UNLESS OTHERWISE SPECIFIED)				
DRAWN	G.DOUGLAS	DATE	08/18/08	
CHECK		DATE		
ENGINEERING		DATE		
LINEAR		INCHES	mm	
X.XXX	±.001		±0.03	
X.XX	±.01		±0.1	
X.X	±.05		±0.3	
X	±.06		±1	
DEC.	±.5		±0.5	
FINISH		CS	1.6	
THIRD ANGLE PROJECTION				
NEXT ASSY	SYSTEM			
SOFTWARE				
AUTOCAD	2000			
DRAWING NO.		A2 11902621		
REV		A		
SCALE		1:4 WT kg		
SHEET		1 OF 1		

GMM
 955 Industrial Rd, San Carlos, CA 94070
 Tel: (650)802-8292. Fax: (650)802-8298.

TITLE
**MOTORIZED ROTATING DRIVE
 MODEL: 3474 INSTALLATION**

PROPRIETARY
 THIS DRAWING CONTAINS CONFIDENTIAL INFORMATION
 PROPRIETARY TO GMW INC. IT MUST NOT BE
 REPRODUCED OR DISCLOSED TO OTHERS OR USED IN ANY
 OTHER WAY, IN WHOLE OR IN PART EXCEPT AS AUTHORIZED
 IN WRITING BY GMW INC.

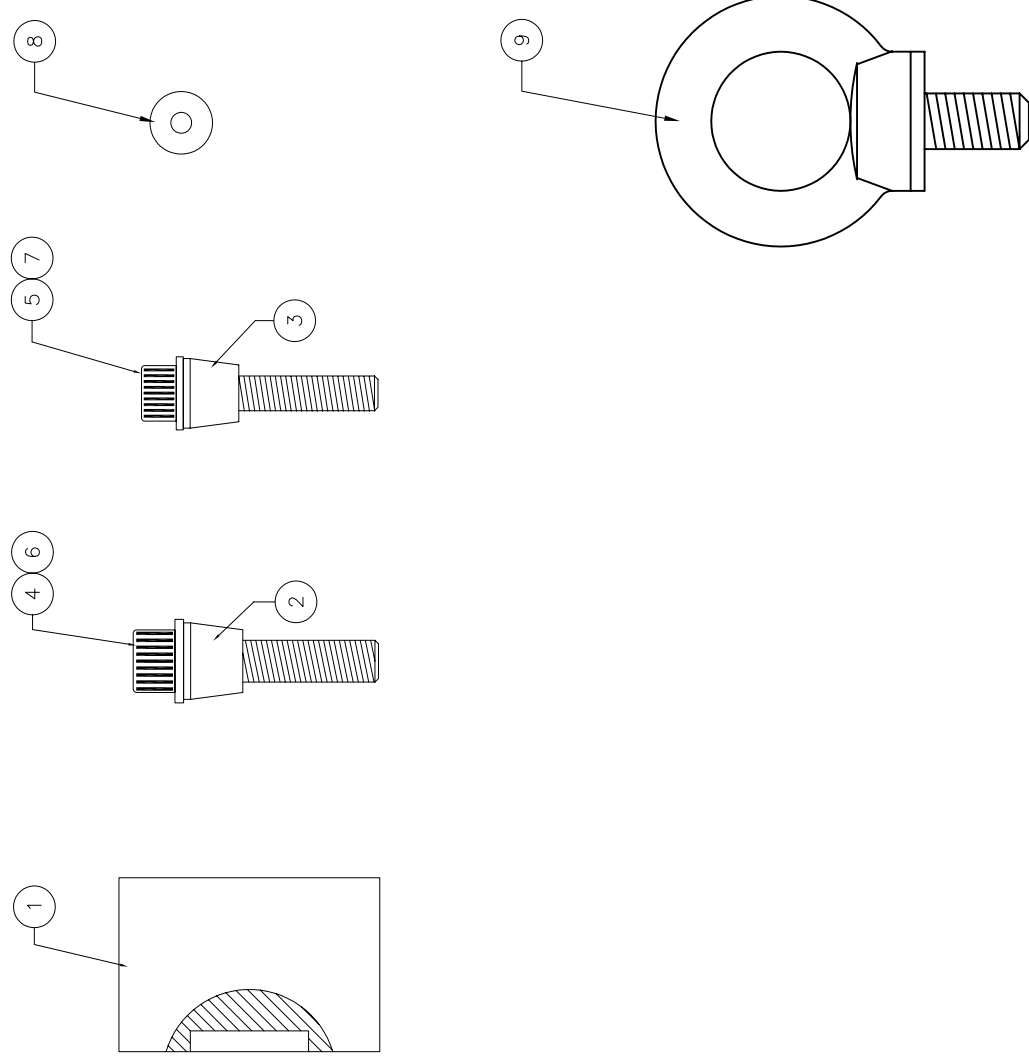

ITEM	QTY	PART NUMBER	DESCRIPTION	NOTE
9	2		EYEBOLT, M16	
8	16	BN 748	WASHER, SHIM 6 x 18 x 0.5 THICK BOSSARD	
7	3	DIN 433	WASHER, M10 x 1.6 THICK	
6	3	DIN 433	WASHER M12 x 2 THICK	
5	3	DIN 912	SHSC M10 x 40 S/S	
4	3	DIN 912	SHSC M12 x 40 S/S	
3	3	17906310	SPOOL ALIGNMENT BUSH	
2	3	17906320	TRANSITION PLATE ALIGNMENT BUSH	
1	4	17906330	BASE FLOOR SPACER	

PARTS LIST		
DO NOT SCALE FROM DRAWING	GMW 955 Industrial Rd, San Carlos, CA 94070 Tel: (650)802-8292. Fax: (650)802-8298.	
DIMENSIONS & TOLERANCES (UNLESS OTHERWISE SPECIFIED)		
LINEAR	INCHES	mm
X.XXX	±.001	±0.03
X.XX	±.01	±0.1
X.X	±.05	±0.3
X	±.06	±1
DEC.	±.5	±0.5
FINISH	63	1.6
THIRD ANGLE PROJECTION		
SOFTWARE	AUTOCAD 2000	
SCALE	1:1	WT kg
SHEET	1	OF 1

REV	DESCRIPTION	DRAFT	DATE	APPROVED
A	RELEASE		08/24/08	G.DOUGLAS

TITLE	DRAWING NO.	REV
MOTORIZED ROTATING DRIVE INSTALLATION KIT	A2 11902640	A

PROPRIETARY
 THIS DRAWING CONTAINS CONFIDENTIAL INFORMATION
 PROPRIETARY TO GMW INC. IT MUST NOT BE
 REPRODUCED OR DISCLOSED TO OTHERS OR USED IN ANY
 OTHER WAY, IN WHOLE OR IN PART EXCEPT AS AUTHORIZED
 IN WRITING BY GMW INC.

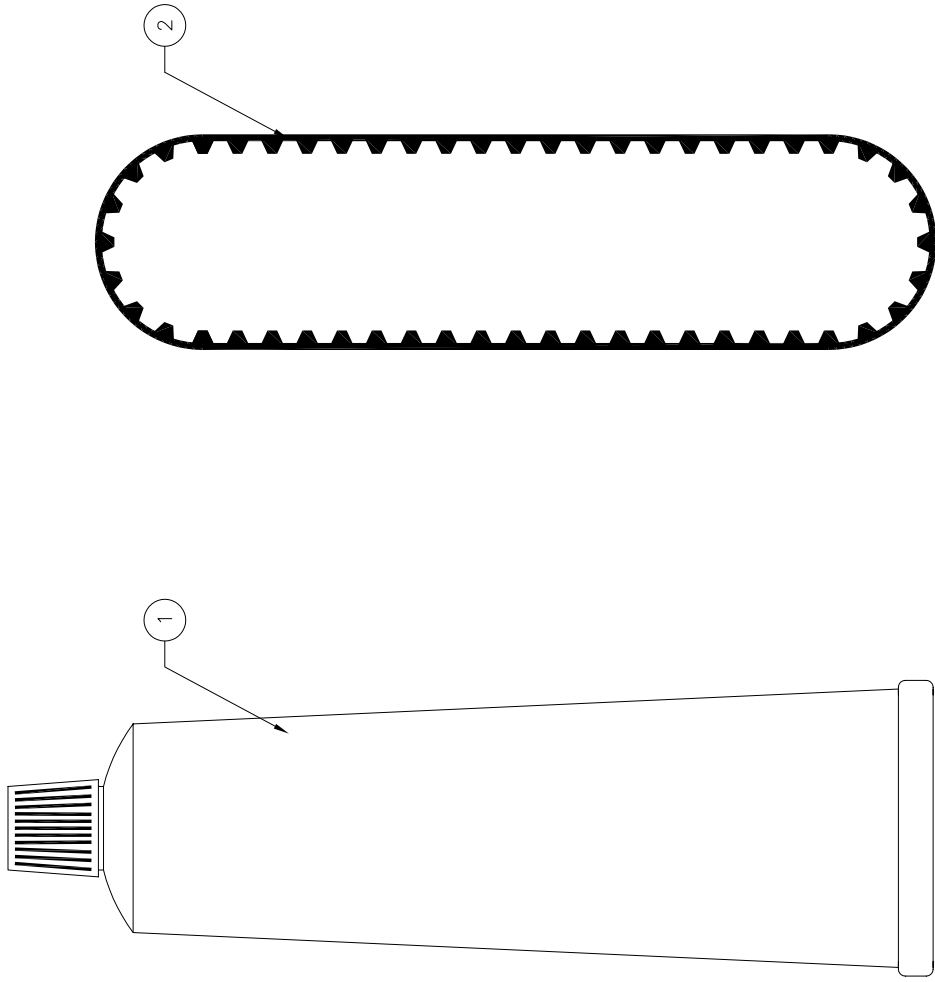

REV	RELEASE	DESCRIPTION	DRAFT	DATE	APPROVED
A				08/24/08	G.DOUGLAS

REVISIONS

ITEM	QTY	PART NUMBER	DESCRIPTION	NOTE
2	1	TB20EF6-55	BELT,TIMING, 250mm [11"] Long BERG	
1	1	RS# 118-0567	GREASE, MULTIPURPOSE, 50ml Tube	

PARTS LIST

DO NOT SCALE
 FROM DRAWING
 DIMENSIONS & TOLERANCES
 (UNLESS OTHERWISE SPECIFIED)

LINEAR	INCHES	mm
X.XXX	±.001	±0.03
X.XX	±.01	±0.1
X.X	±.05	±0.3
X	±.08	±1
DEC.	±.5	±0.5
FINISH	63	1.6

THIRD ANGLE PROJECTION



GMW
 955 Industrial Rd, San Carlos, CA 94070
 Tel: (650)802-8292. Fax: (650)802-8298.

TITLE
**MOTORIZED ROTATING DRIVE
 SPARE PARTS KIT**

DRAWING NO.
A2 11902650

REV
A

SOFTWARE
 AUTOCAD 2000

SCALE 1:1

WT kg

1

SHEET 1

OF 1

PROPRIETARY
 THIS DRAWING CONTAINS CONFIDENTIAL INFORMATION
 WHICH IS THE PROPERTY OF GMW. IT IS TO BE KEPT
 SEPARATELY OF ALL OTHERS AND NOT TO BE REPRODUCED
 OR DISCLOSED TO OTHERS IN ANY MANNER WITHOUT THE
 WRITTEN CONSENT OF GMW.

TOP VIEW

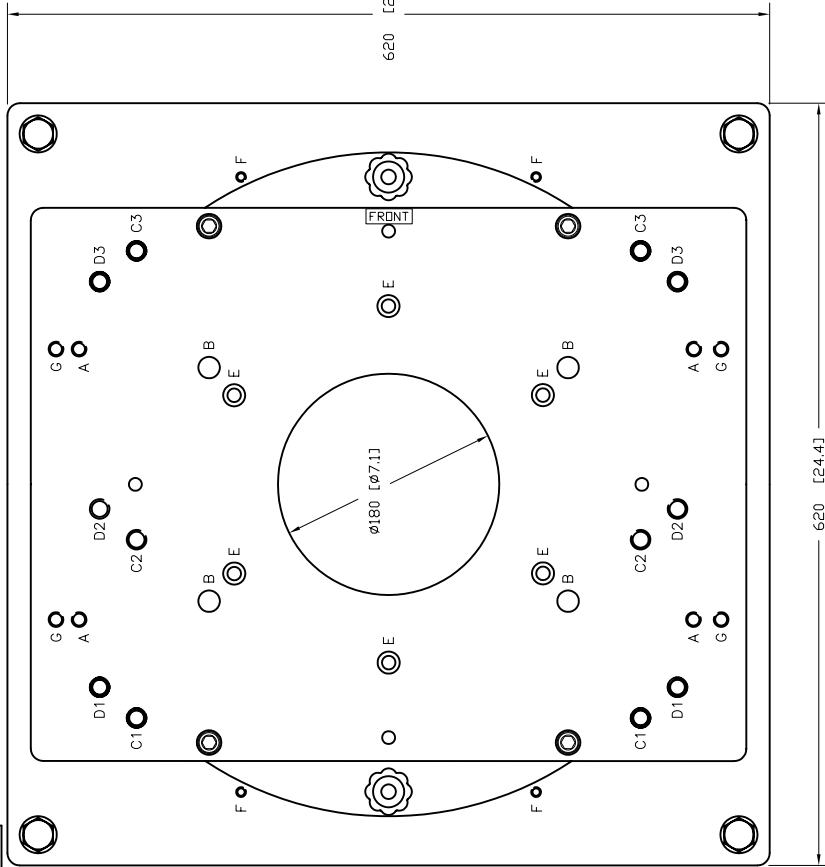

FRONT VIEW

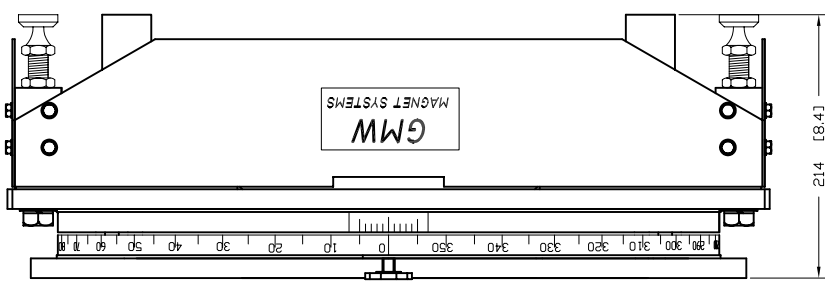

MOUNTING HOLES	
A=5403	DIRECT MOUNTING
B=3473/3472	DIRECT MOUNTING
C1/C2=3472	45° MOUNTING
D1/D2=3473	45° MOUNTING
C1/C3=3472	HORZ MOUNTING
D1/D3=3473	HORZ MOUNTING
E=MRD	SPOOL MOUNTING
F=MRD	MOTOR DRIVE MOUNTING
G=5403EG	DIRECT MOUNTING

ROTATION LOCKS
 UNDO TO ALLOW ROTATION
 TIGHTEN TO STOP ROTATION

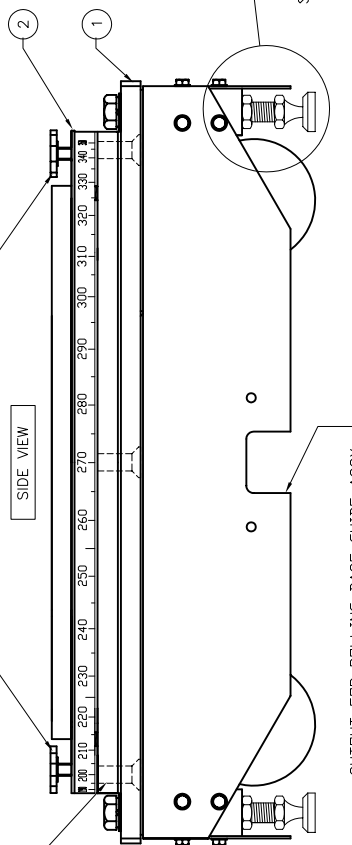

LOCKNUT

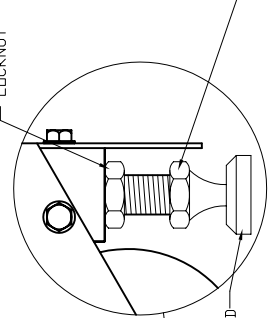

CUTOUT FOR ROLLING BASE GUIDE ASSY
 DWG NO 11901330

SELF ALIGNING PAD
 SCREW NUT IN/OUT TO ADJUST HEIGHT
 AND LEVEL OF ROTATING/ROLLING BASE

NOTE

1 PART OF ROTATING BASE ASSY SEE DWG NO: 11802090

REV	DESCRIPTION	DATE	APPROVED
A	RELEASE	04/27/94	G.DOUGLAS
B	ADD 5403 MITG HOLES	05/13/95	G.DOUGLAS
C	ADD MOTORIZED ROTATING BASE HOLES	07/05/97	G.DOUGLAS
D	ADD 'G' HOLES: INCR TRANSITION PLATE SIZE	06/27/03	G.DOUGLAS
E	CORRECT TRANSITION PLATE HOLE CALLOUT: ADD FOOT VIEW	04/14/04	G.DOUGLAS
F	DELETE ITEM 3. ADD ROTATION LOCK NOTE & NOTE 1	08/29/08	G.DOUGLAS

ITEM	QTY	PART NUMBER	DESCRIPTION	NOTE
2	1	11802090	ROTATING BASE ASSEMBLY	
1	1	11803170	ROLLING BASE ASSEMBLY	

PARTS LIST	
DATE	04/27/94
FROM DRAWING	955 Industrial Rd, San Carlos, CA 94070
UNLESS OTHERWISE SPECIFIED	Tel: (650)802-8292, Fax: (650)802-8298.
ENGINEERING	
DESIGNER	
CHECKER	
DATE	
SCALE	AS SHOWN
TITLE	ROT/ROLLING BASE
SIZE	3473/3472/5403
THIRD ANGLE PROJECTION	
DRAWING NO.	A111803430
REV	F

REV	ASSY	SYSTEM	SOFTWARE	SCALE	SHEET	OF
	AUTOCAD	2000		1:2	1	1

PROPRIETARY
 THIS DRAWING CONTAINS CONFIDENTIAL INFORMATION.
 REPRODUCTION OR DISSEMINATION TO OTHERS OR USE IN ANY
 MANNER WITHOUT THE EXPRESS WRITTEN PERMISSION OF
 GMW MAGNET SYSTEMS, INC.

REV	RELEASE	DESCRIPTION	DRAWN	DATE	APPROVED
A	NEW 1/7B, ADD ITEM 13, MOVE 2.3, SHIFT "A" HOLES		Z.MARTIN	08/04/93	Z.MARTIN
B	ADD MAGNET HORIZONTAL MOUNTING HOLES			04/29/94	G.DOOUGLAS
C	ADD 5403 MIG HOLES			05/08/94	G.DOOUGLAS
D	ADD MRD MOTOR DRIVE MOUNTING HOLES			05/13/95	G.DOOUGLAS
E	ADD ITEM 16, AND G-5403EG MOUNTING HOLES			10/21/98	G.DOOUGLAS
F	ADD ENLARGED FOOT VIEW. NOTE 1			06/28/03	G.DOOUGLAS
G	CHANGE ITEM 19 PART NO.			04/14/04	G.DOOUGLAS
H				11/7/09	G.DOOUGLAS

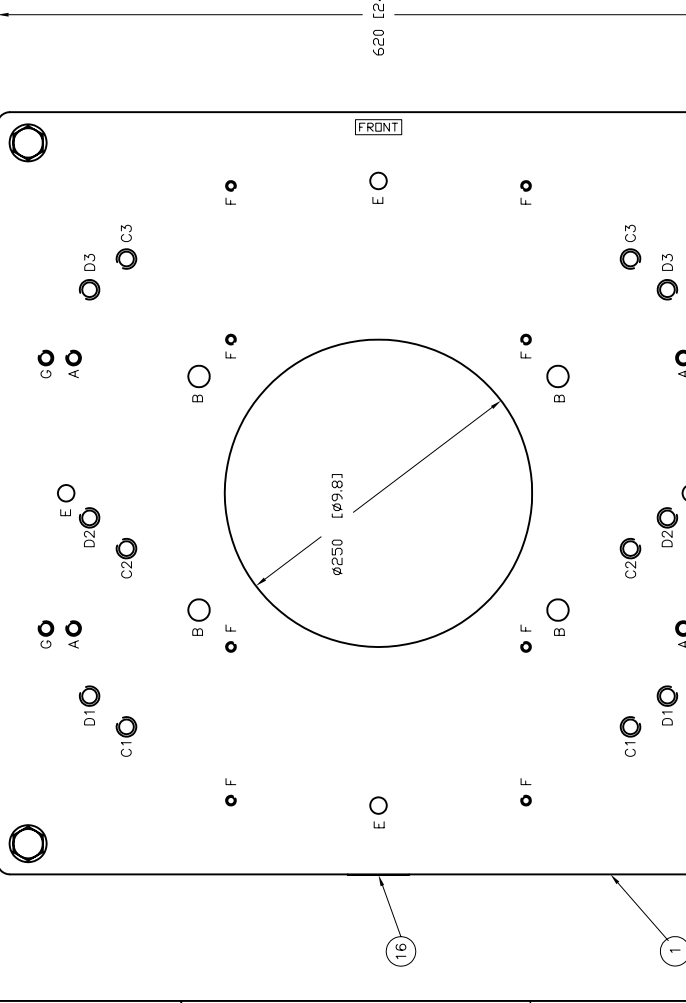
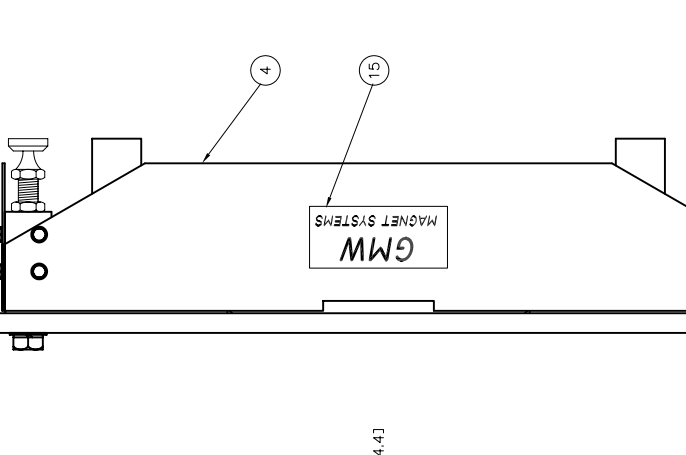
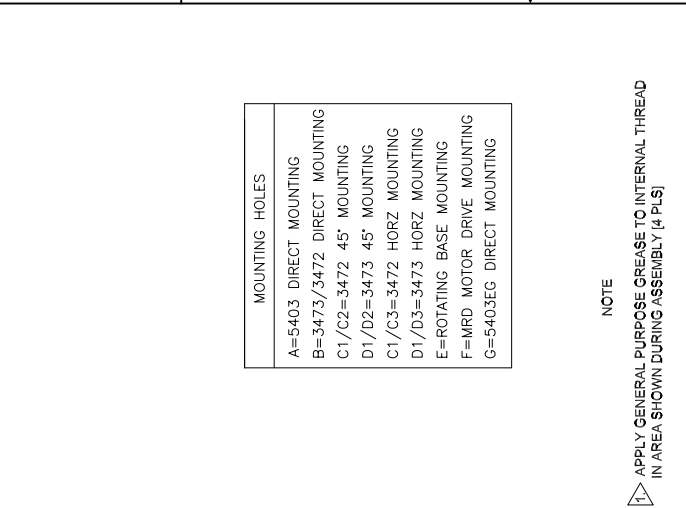

MOUNTING HOLES

A=5403 DIRECT MOUNTING
 B=3473/3472 DIRECT MOUNTING
 C1/C2=3472 45° MOUNTING
 D1/D2=3473 45° MOUNTING
 C1/C3=3472 HORZ MOUNTING
 D1/D3=3473 HORZ MOUNTING
 E=ROTATING BASE MOUNTING
 F=MRD MOTOR DRIVE MOUNTING
 G=5403EG DIRECT MOUNTING

NOTE

1 APPLY GENERAL PURPOSE GREASE TO INTERNAL THREAD
 IN AREA SHOWN DURING ASSEMBLY (4 PLS)

ITEM	QTY	PART NUMBER	DESCRIPTION	NOTE
16	1	10901110	LABEL, IDENTIFICATION	
15	1	10900200	LABEL, GMW MAGNET SYSTEMS	
14	4	DIN 125 A	M16 X 3 THICK WASHER, FLAT S/S	
13	4	DIN 127 B	M16 WASHER, SPRING S/S	
12	4	DIN 933	M16 X 40 HEX HD BOLT, S/S	
11	16	DIN 127 B	M6 WASHER, SPRING S/S	
10	16	DIN 433	M6 X 8 HEX HD BOLT S/S	
9	16	DIN 933	M6 X 8 HEX HD BOLT S/S	
8	2	REX CHDS 4RT	CASTER, SWIVEL	
7	2	REX CHDF 4RT	CASTER, FIXED	
6	4	17802180	LEVELING FOOT	
5	4	17802180	SUPPORT LEG	
4	1	17802123	SKIRT PANEL, FRONT	
3	1	17802122	SKIRT PANEL, REAR	
2	2	17802121	SKIRT PANEL, SIDE	
1	1	17802110	BASE PLATE	

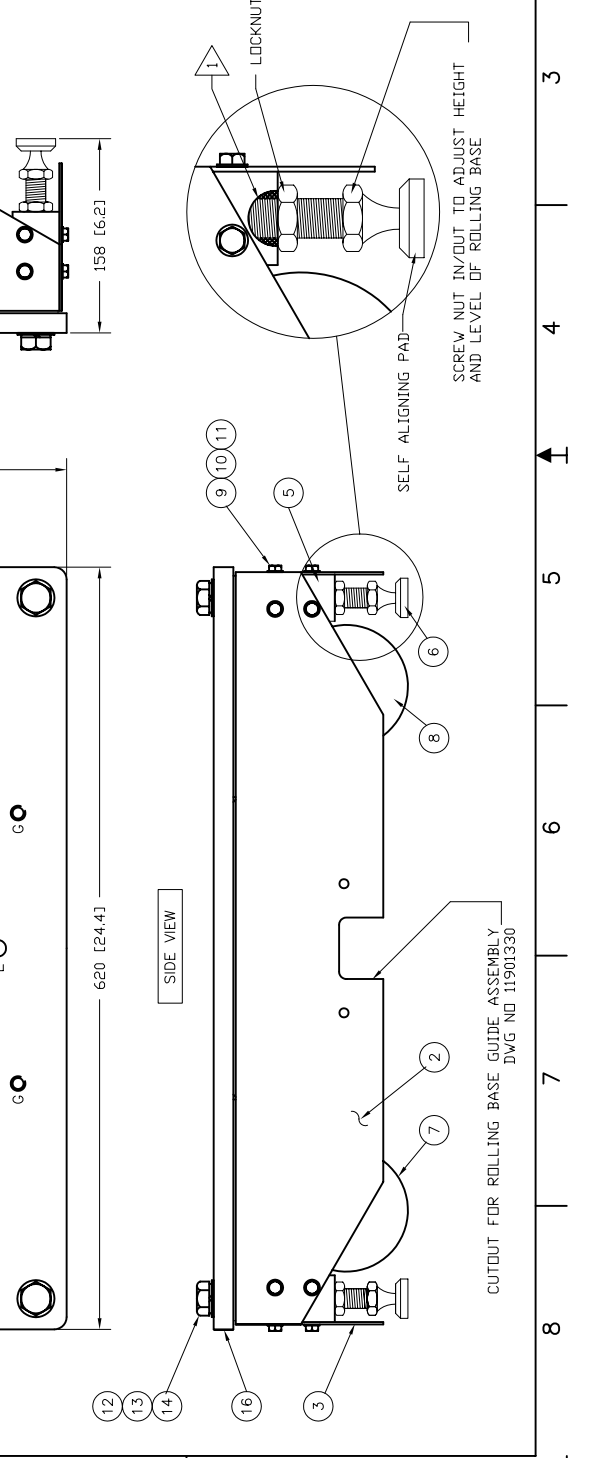

PARTS LIST	
DATE	08/04/93
DRAWN	Z.MARTIN
DATE	04/29/94
ENGINEER	G.DOOUGLAS
DATE	05/08/94
ENGINEER	G.DOOUGLAS
DATE	05/13/95
ENGINEER	G.DOOUGLAS
DATE	10/21/98
ENGINEER	G.DOOUGLAS
DATE	06/28/03
ENGINEER	G.DOOUGLAS
DATE	04/14/04
ENGINEER	G.DOOUGLAS
DATE	11/7/09
ENGINEER	G.DOOUGLAS

DO NOT SCALE FROM DRAWING UNLESS OTHERWISE SPECIFIED

GMW
 955 Industrial Rd, San Carlos, CA 94070
 Tel: (650)802-8292, Fax: (650)802-8298

ROLLING BASE ASSY
 3473/3472/5403

SCALE: 1:2 1/4" = 1"

SOFTWARE: AUTOCAD 2000

REVISION NO. A111803170

SCALE: 1:2 1/4" = 1"

SHEET 1 OF 1

PROPRIETARY
 THIS DRAWING CONTAINS CONFIDENTIAL INFORMATION.
 REPRODUCTION OR TRANSMISSION OF THIS DRAWING
 IN ANY MANNER WITHOUT THE WRITTEN PERMISSION OF
 GMW INC.

TOP VIEW

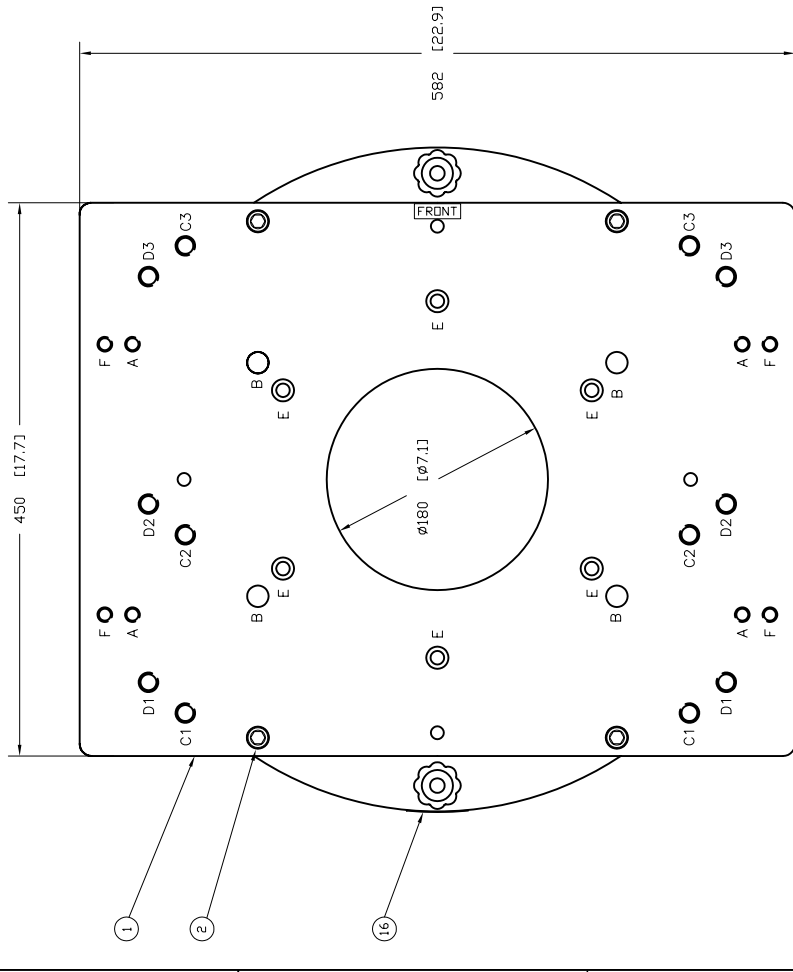

FRONT VIEW

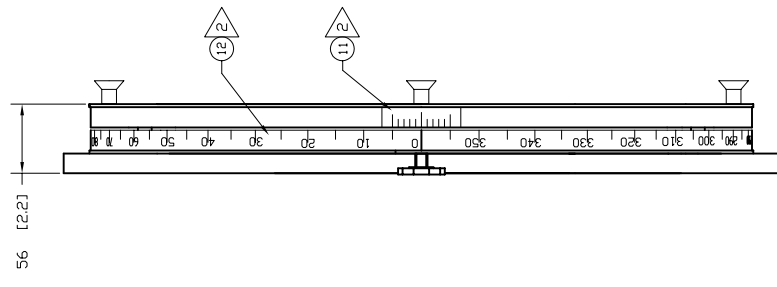

ROTATION LOCKS
 UNDO TO ALLOW ROTATION
 TIGHTEN TO STOP ROTATION

SIDE VIEW

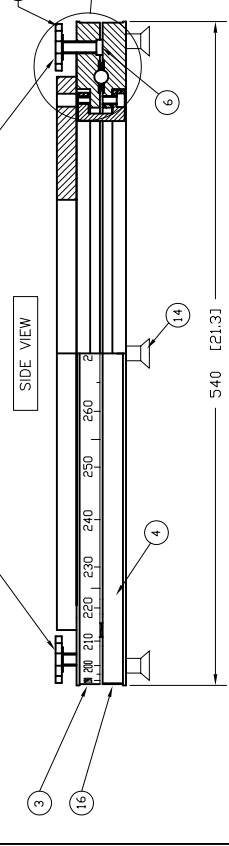

DETAILED VIEW

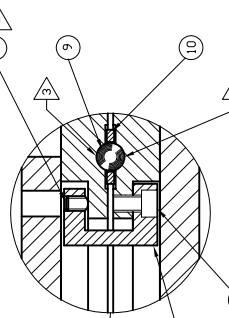

SCALE: 2:1

REV	RELEASE	DESCRIPTION	DRAWN	DATE	APPROVED
A		NEW 1/8" SHIFT ITEM 11 & 12 TO FRONT OF BASE.	J. MARTIN	04/27/94	J. MARTIN
B		ADD HORIZONTAL MTC HOLES @ 85/95		04/29/94	G. DOUGLAS
C		ADD 5403 MTC HOLES, DELETE BASE PLATE		05/07/94	G. DOUGLAS
D		ADD MOTORISED ROT BASE SPOOL HOLES @ C7		04/28/95	G. DOUGLAS
E		CRG ITEM 9 AND ITEM 13		09/20/97	G. DOUGLAS
F		ADD ITEM 16, F HOLES, INCR TRANSMISSION PLATE SIZE		07/29/98	G. DOUGLAS
G		CRG ITEM 14 TO SHCS		06/27/03	G. DOUGLAS
H		CRG ITEM 14 TO SHCS		04/15/04	G. DOUGLAS
I		ADD NOTE @ A7, CRG ITEM 14, DELETE 15		08/29/08	G. DOUGLAS

MOUNTING HOLES	
A=5403	DIRECT MOUNTING
B=3473/3472	DIRECT MOUNTING
C1/C2=3472	45° MOUNTING
D1/D2=3473	45° MOUNTING
C1/C3=3472	HORZ MOUNTING
D1/D3=3473	HORZ MOUNTING
E=	MOTORISED ROT BASE SPOOL
F=5403EG	DIRECT MOUNTING

NOTES

- ADJUST SET SCREW FOR MINIMUM CLEARANCE ALLOWING FOR FULL FREE ROTATION; AND LOCTITE IN PLACE.
- FORM DECAL TO PLATE DIA TO PREVENT ENDS FROM SPRINGING LOOSE.
- APPLY GREASE TO BEARING SURFACES BEFORE ASSEMBLY.

ITEM	QTY	PART NUMBER	DESCRIPTION	NOTE
16	1	10901140	LABEL, IDENTIFICATION	
15			DELETED	
14	4	DIN 7991	SCREW, M12 x 35 SK FLAT HD CAP, S/S	
13	4	DIN 913	SCREW, M6 x 8 SHSS, OVAL PT, S/S	
12	1	10901150	LABEL, ANGLE GRADUATIONS 0-360°	
11	1	10901160	LABEL, VERNIER INDEX	
10	1	17802140	SPACER, BEARING	
9	32	RB-11.906	BALL BEARING 11.91mm [15/32"] DIA SKF	
8	4	DIN 912	SCREW, M6 x 10 SK HD CAP, S/S	
7	4	17802150	CLAMP, RETAINING	
6	2	17901340	CLAMP PAD	
5	2	17802170	HANDWHEEL, M10	
4	1	17802132	LOWER THRUST BEARING PLATE	
3	1	17802131	UPPER THRUST BEARING PLATE	
2	4	DIN 912	SCREW, M12 x 20 SK HD CAP, S/S	
1	1	17802100	TRANSITION PLATE	

DO NOT SCALE FROM DRAWING UNLESS OTHERWISE SPECIFIED

DATE: 04/27/94
 DRAWN BY: J. MARTIN
 CHECKED BY: []
 ENGINEERING DATE: []

LINE	UNITS	INCHES	MILLIMETERS
A	3.250	0.003	
B	3.750	0.015	
C	3.750	0.015	
D	3.750	0.015	
E	3.750	0.015	
F	3.750	0.015	
G	3.750	0.015	
H	3.750	0.015	
I	3.750	0.015	

SCALE: 1:2 WT/KG

GMW
 955 Industrial Rd, San Carlos, CA 94070
 Tel: (650)802-8292, Fax: (650)802-8298

TITLE: ROTATING BASE
 3473/3472/5403

SIZE: DRAWING NO. A111802090

REV: 1

SOFTWARE: AUTOCAD 2000

SHEET 1 OF 1

PROPRIETARY
THIS DRAWING CONTAINS CONFIDENTIAL INFORMATION
PROPRIETARY TO GMW INC. IT MUST NOT BE
REPRODUCED OR DISCLOSED TO OTHERS OR USED IN ANY
OTHER WAY, IN WHOLE OR IN PART EXCEPT AS AUTHORIZED
IN WRITING BY GMW INC.

TOP VIEW

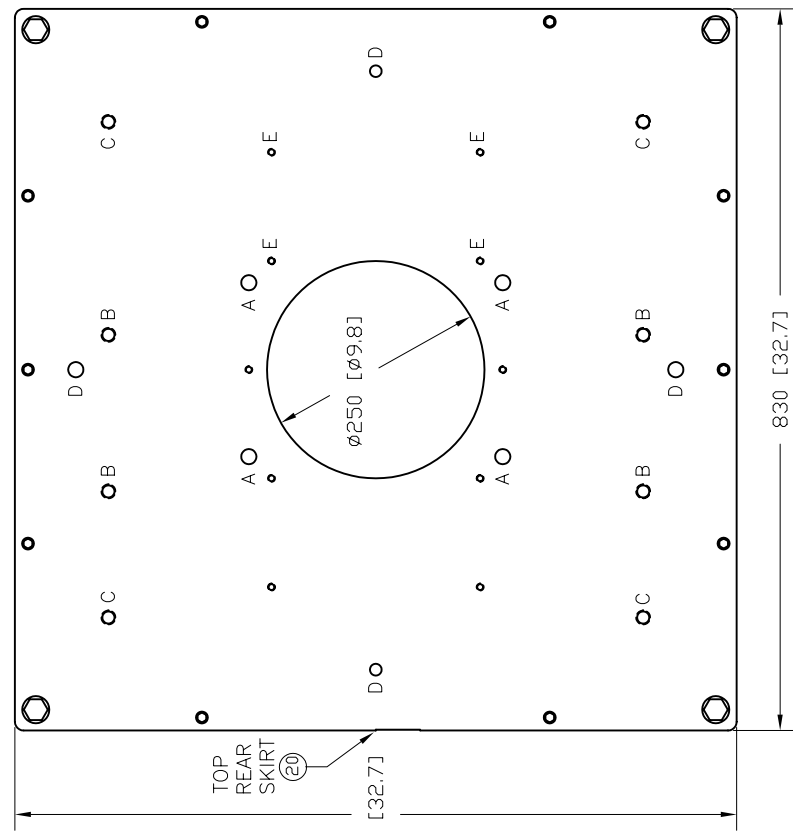

FRONT VIEW

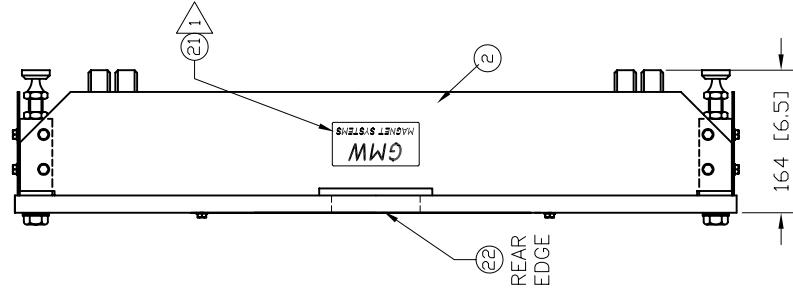

REV	DESCRIPTION	DRAFT	DATE	APPROVED
B	REDRAWN		12/06/92	A.MARTIN
C	ADD TOP VIEW, HORZ/MTG HOLES "C"		03/04/97	G.DOUGLAS
D	ADD MRD MOUNTING HOLES, CHG PARTS LIST		11/13/97	G.DOUGLAS
E	CHG POSITION OF ITEM 22, ITEMS 7 & 8 NOW FITTED AT B/S		07/21/03	G.DOUGLAS
F	ADD DETAIL @ A2, AND NOTE 2		09/29/08	G.DOUGLAS

MOUNTING HOLES
A=3474 DIRECT MOUNTING
B=3474 45 DEG MOUNTING
C=3474 HORZ MOUNTING
D=ROTATING BASE MOUNTING
E= MRD MOTOR DRIVE MOUNTS

- 1 FIT LABEL ON CENTER LINE 35mm UP FROM BOTTOM OF SKIRT
- 2 APPLY GENERAL PURPOSE GREASE TO INTERNAL THREAD [x4]

ITEM	QTY	PART NUMBER	DESCRIPTION	NOTE
22	1	10900210	LABEL, IDENTIFICATION	
21	1	10900200	LABEL, GMW MAGNET SYSTEMS	
20	1	1605-677	RUBBER PLUG, 30MM DIA OD R-S	
19	26	DIN 127 B	WASHER, SPRING M6, S/S	
18	26	DIN 125 A	WASHER, FLAT M6, S/S	
17	16	DIN 933	BOLT, HEX M6 X 12, S/S	
16	10	DIN 933	BOLT, HEX M6 X 30, S/S	
15	16	DIN 127 B	WASHER, LOCK M10, S/S	
14	16	DIN 125 A	WASHER, FLAT M10, S/S	
13	16	DIN 933	BOLT, HEX M10 X 20, S/S	
12	4	DIN 127 B	WASHER, LOCK M16, S/S	
11	4	DIN 125 A	WASHER, FLAT M16, S/S	
10	4	DIN 933	BOLT, HEX M16 X 30, S/S	
9	4	DIN 439 B	NUT, M16 HALF S/S	
8	2		CASTER, SWIVEL ALBION 2-72-TM-03101-S	
7	2		CASTER, FIXED ALBION 2-72-TM-013101-R	
6	4	17904540	LEVELING FOOT	
5	4	17801820	SUPPORT LEG	
4	1	17801793	SKIRT PANEL, REAR	
3	2	17801792	SKIRT PANEL, LH & RH SIDE	
2	1	17801791	SKIRT PANEL, FRONT SIDE	
1	1	17801810	BASE PLATE	

PARTS LIST		DO NOT SCALE FROM DRAWING DIMENSIONS & TOLERANCES (UNLESS OTHERWISE SPECIFIED)		TITLE	
DRAWN	A.MARTIN	DATE	12/06/92	LINEAR	±.003
CHECK		DATE		X.XX	±.01
ENGINEERING		DATE		X.X	±.03
				X	±.06
				DEC.	±.5
				FINISH	63/1.6
				THIRD ANGLE PROJECTION	
NEXT ASSY		SYSTEM	3474		
SOFTWARE	AUTOCAD	VERSION	2000		

GMW
955 Industrial Rd, San Carlos, CA 94070
Tel: (650)802-8292. Fax: (650)802-8298.

ROLLING BASE ASSY
MODEL: 3474

REV F
DRAWING NO. A2 11801800
SCALE 1:4 WT kg SHEET 1 OF 1

SIDE VIEW

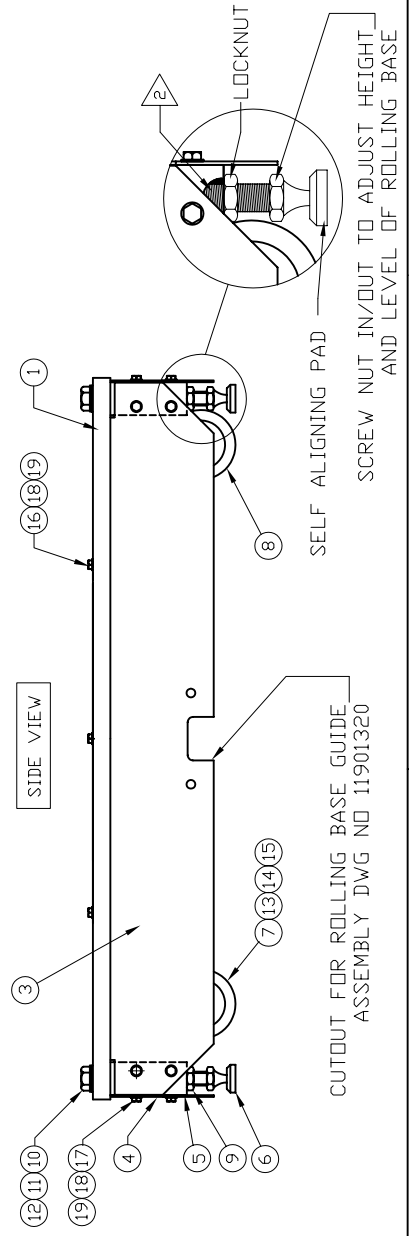

PROPRIETARY
THIS DRAWING CONTAINS CONFIDENTIAL INFORMATION
PROPRIETARY TO G.M.W. INC. IT MUST NOT BE
REPRODUCED OR DISCLOSED TO OTHERS OR USED IN ANY
OTHER WAY, IN WHOLE OR IN PART EXCEPT AS AUTHORIZED
IN WRITING BY G.M.W. INC.

TOP VIEW

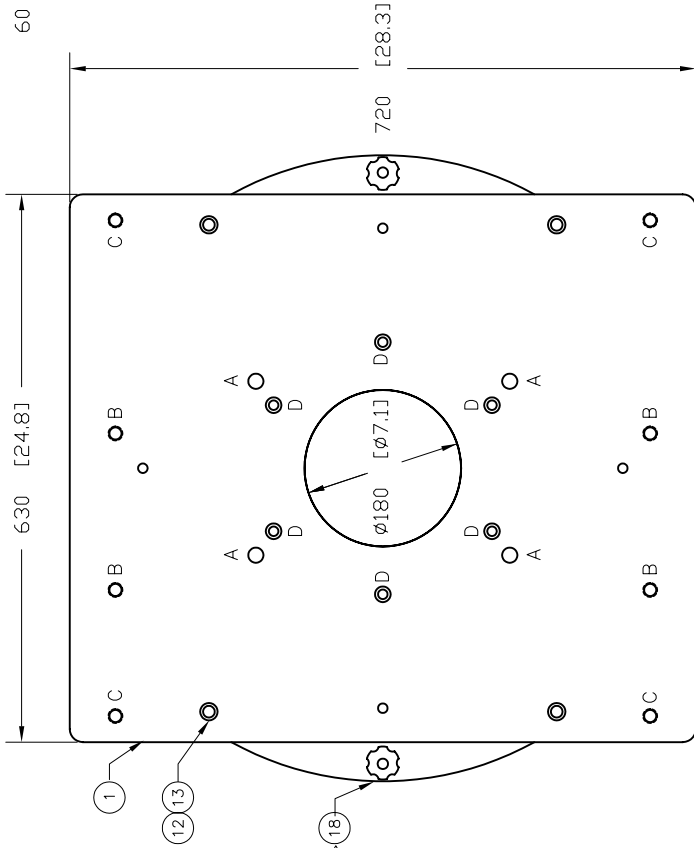

FRONT VIEW

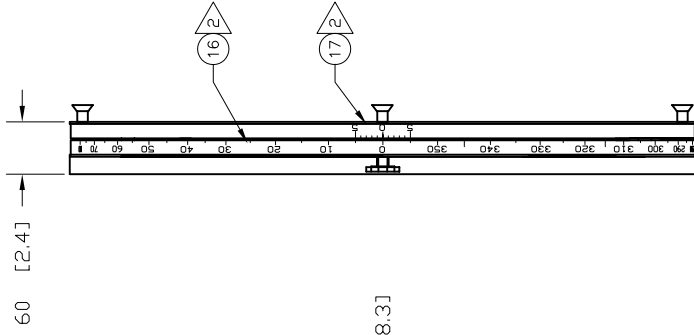

ROTATION LOCKS
UNDO TO ALLOW ROTATION
TIGHTEN TO STOP ROTATION

SIDE VIEW

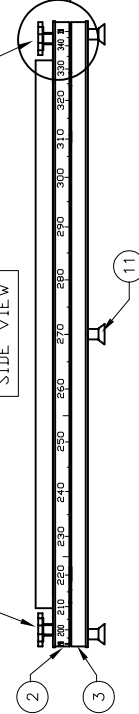

DETAILED VIEW

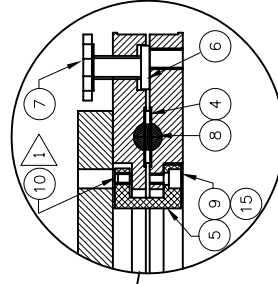

SCALE 2:1

NOTES:

- 1 ADJUST SET SCREW FOR MINIMUM CLEARANCE.
ALLOW FOR ROTATION WITHOUT BINDING, THEN LOCTITE SHSC.
- 2 FORM LABEL TO RING DIA, CLEAN SURFACE BEFORE FITTING.
- 3 FIT ITEM 18 DIRECTLY OPPOSITE ITEM 17 ON LOWER THRUST RING.
4. APPLY GREASE TO BEARING SURFACES BEFORE ASSEMBLY.

REVISIONS

REV	DESCRIPTION	DRAFT	DATE	APPROVED
A	RELEASE		11/15/93	G.DOUGLAS
B	CHG BALL GROVE AND ITEM 8 FROM 15.00 TO 15.88		07/28/98	G.DOUGLAS
C	ADD ROTATION LOCK NOTE @ B4, DELETE ITEM 14		08/29/08	G.DOUGLAS

MOUNTING HOLES	
A=3474	DIRECT MOUNTING
B=3474	45 DEG MOUNTING
C=3474	HORZ MOUNTING
D=	MRB SPOOL MOUNTS

ITEM	QTY	PART NUMBER	DESCRIPTION	NOTE
18	1	10900140	LABEL, IDENTIFICATION	
17	1	10900130	LABEL, INDEX	2
16	1	10900120	LABEL, GRADUATIONS 0-360°	2
15	4	BN 792	WASHER, M6 INT RIBBED LOCK SP/S	
14			DELETED	
13	4	BN 792	WASHER, M12 INT RIBBED LOCK SP/S	
12	4	DIN 912	SHCS, M12 X 25 S/S	
11	4	DIN 7991	SHCS, M12 X 35 FLAT HEAD S/S	
10	4	DIN 916 A2	SHSS, M6 X 8 OVAL POINT S/S	1
9	4	DIN 912	SHCS, M6 X 10 S/S	
8	64	RB-15.875	BALL BEARING, 15.88MM DIA, [5/8"]SKF	
7	2	17802170	HANDWHEEL, M10	
6	2	17901330	CLAMP PAD	
5	4	17802150	RETAINING CLAMP	
4	1	17901320	BEARING SPACER	
3	1	17901312	LOWER THRUST RING	
2	1	17901311	UPPER THRUST RING	
1	1	17901300	TRANSITION PLATE	

PARTS LIST

DO NOT SCALE FROM DRAWING
DIMENSIONS & TOLERANCES
(UNLESS OTHERWISE SPECIFIED)

LINEAR	INCHES	MM
X.XXX	±.001	±0.03
X.XX	±.01	±0.1
X.X	±.05	±0.3
X	±.06	±1
DEC.	±.5	±0.5
FINISH	63	1.6

THIRD ANGLE PROJECTION

SCALE 1:4 WT kg

REV C

DRAWING NO. A2 11900990

MODEL: 3474

ROTATING BASE ASSY

955 Industrial Rd, San Carlos, CA 94070
Tel: (650)802-8292. Fax: (650)802-8298.

G.M.W.