

**DESCRIPTION:**

The I1A denotes a range of SENIS Magnetic Field-to-Voltage Transducers with integrated 1-axis Hall Probe. It measures magnetic fields perpendicular to the probe plane (By).

The Hall Probe contains a CMOS integrated circuit, which incorporates three groups of mutually orthogonal Hall elements and a temperature sensor. The integrated Hall elements occupy very small area (150µm x 150µm), which provides very high spatial resolution of the probe

The Hall probe is connected with an electronic box (Module E in Fig. 1). The Module E provides biasing for the Hall probe and the application of the spinning-current technique, which cancels offset, low frequency noise and the planar Hall effect. The additional conditioning of the Hall probe output signals in the electronic box includes Hall signal amplification, high linearization, compensation of the temperature variations, and limitation of the frequency bandwidth.

The outputs of the I1A Magnetic Transducers are available at the connector CoS of the Module E: this is a high-level differential voltage proportional to the measured transverse (Y) component of a magnetic flux density; and a ground-referred voltage proportional with the probe temperature.

**KEY FEATURES:**

- **Integrated CMOS 1-axis Hall Probe (measures magnetic fields perpendicular to the probe plane By)**
- **Very low noise and offset fluctuations**
- **Very high linearity**
- **Negligible inductive loops on the Probe**
- **Integrated temperature sensor on the probe for temperature compensation**

**TYPICAL APPLICATIONS:**

- Characterization and quality control of permanent magnets
- Development of magnet systems
- Mapping magnetic field
- Quality control and monitoring of magnet systems (generators, motors, etc.)
- Application in laboratories and in production lines, etc.

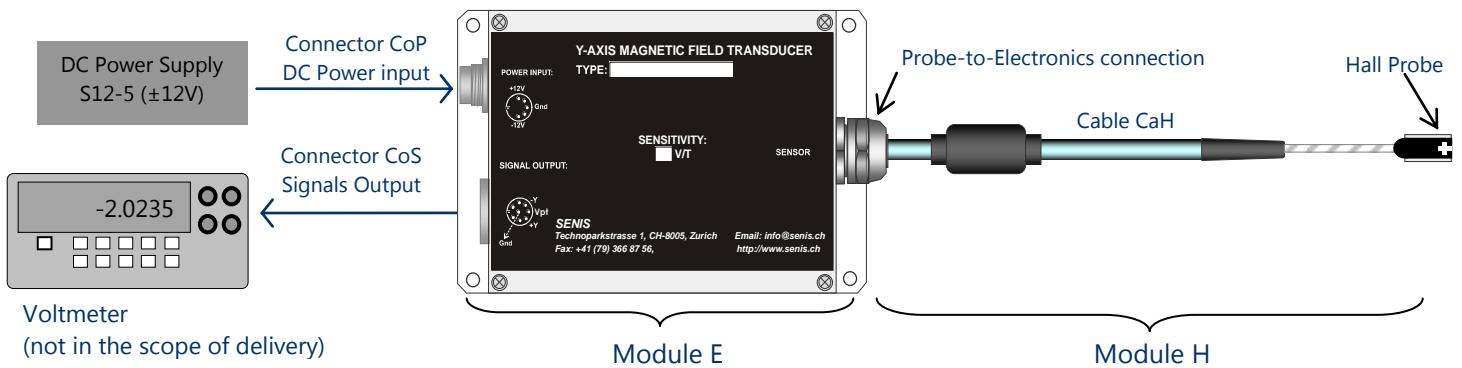





Figure 1. **Typical measurement setup with a SENIS magnetic-field-to-voltage transducer with integrated Hall Probe (Module H) and Electronic (Module E)**



Figure 2. Photo of a 1-axis magnetic field transducer with integrated Hall Probe

### SPECIFICATIONS (Module H):

A number of different geometries/dimensions of Hall probes available that fulfills a wide range of application requirements:

FIGURE				
Probe type	A <sup>1)</sup>	G <sup>2)</sup>	H <sup>3)</sup>	K <sup>2)</sup>
Ext. dimensions L x W x H (mm)	16.5 x 5.0 x 2.3	42.0 x 2.0 x 0.5	42.0 x 2.0 x 1.1	47.0 x 2.0 x 0.5

### REMARKS:

- 1) Very robust standard package;
- 2) Very thin and long Probes with naked silicon chip. Caution: the naked silicon die is fragile.
- 3) Very thin and long Probes with protected silicon chip. Caution: the naked silicon die is fragile.

For Probe selection, please see Hall Probes Sections at [www.senis.ch](http://www.senis.ch)

The sensor chip is embedded in the probe package and connected to the CaH cable.

CaH Cable - Dimensions and Tolerances:

**Fixed connection**

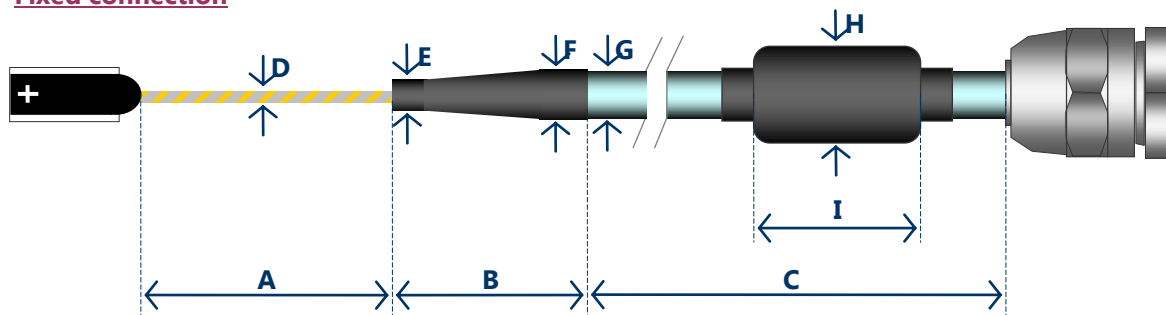

Dimension	mm	Remark
<b>A</b>	50 ± 1	standard for A packages; maximum 1m
	150 ± 3	standard for G, H and K packages (see page 2)
<b>B</b>	35 ± 3	
<b>C</b>	2m, 5m, 10m ± 1%	Different lengths available upon request
<b>D</b>	∅ 1.7 ± 0.2	for A Hall probe geometries
	∅ 1.1 ± 0.2	for G, H and K Hall probe geometries
<b>E</b>	∅ 4.0 ± 0.2	for A Hall probe geometries
	∅ 3.2 ± 0.2	for G, H and K Hall probe geometries
<b>F</b>	∅ 6 ± 0.2	
<b>G</b>	∅ 4.9 ± 0.1	
<b>H</b>	∅ 16 ± 1	
<b>I</b>	30 ± 1	

Figure 3. Standard dimensions and tolerances of CaH cable (fixed Probe connection only available)

I1x Model Number Chart

<b>I1</b>	<b>x</b>	<b>-</b>	<b>H1</b>	<b>H2</b>	<b>H3</b>	<b>H4</b>	<b>H5</b>	<b>H6</b>	<b>-</b>	<b>E1</b>	<b>E2</b>	<b>E3</b>	<b>E4</b>	<b>E5</b>	<b>E6</b>	<b>E7</b>	<b>E8</b>
<b>Type Id</b>			<b>Module H (6 characters)</b>							<b>Module E (8 characters)</b>							

**I1** is Magnetic Transducer Type Identifier

**x** is a product release version, currently A.

For Module H (6 characters) and Module E (8 characters) see the document MFT Model Numbering Chart.pdf

**MAGNETIC and ELECTRICAL SPECIFICATIONS:**

Unless otherwise noted, the given specifications apply for the transverse measurement channel By at room temperature (23°C) and after a device warm-up time of 15 minutes.

Parameter	Value				Remarks
Standard measurement ranges	<b>± 20mT</b>	<b>± 0.2T</b>	<b>± 2T</b>	<b>± 20T</b>	<i>No saturation of the outputs; Other meas. ranges available</i>
Linear range of magnetic flux density ( $\pm B_{LR}$ )	± 20mT	± 0.2T	± 2T	± 2T	<i>Optimal, fully calibrated meas. range</i>
Total measuring Accuracy (@ $B < \pm B_{LR}$ )	0.1%	0.1%	0.1%	1.0%	<i>See note 1</i>
Output voltages ( $V_{out}$ )	differential				<i>See note 2</i>
Sensitivity to DC magnetic field (S)	500 V/T	50 V/T	5 V/T	0.5 V/T	<i>Differential output; see note 3</i>
Tolerance of sensitivity ( $S_{err}$ ) (@ $B < \pm B_{LR}$ )	0.03%	0.03%	0.03%	0.5%	<i>see notes 3 and 4</i>
Nonlinearity (NL) (@ $B < \pm B_{LR}$ )	0.05%	0.05%	0.05%	0.5%	<i>See note 4</i>
Temperature coefficient of sensitivity	< ± 100 ppm/°C (± 0.01 %/°C)				<i>@ Temperature range 23 °C ± 10 °C</i>
Long-term instability of sensitivity	< 1% over 10 years				
Offset (@ $B = 0T$ ) ( $B_{offs}$ )	<±6 µT	<±20 µT	<±0.2 mT	<±1 mT	<i>@ Temperature range 23 °C ± 5 °C</i>
Temperature coefficient of the offset	<±1 µT/°C	<±4 µT/°C	<±20 µT/°C	<±100 µT/°C	
Offset fluctuation and drift ( $\Delta t = 0.05s, t = 100s$ )	<±5 µT	<±7 µT	<±10 µT	<±50 µT	<i>Peak-to-peak values; See note 5</i>
<b>Output noise</b>					
Noise Spectral Density @ $f > 10$ Hz ( $NSD_w$ )	0.04 µT/√Hz	0.09 µT/√Hz	0.12 µT/√Hz	0.6 µT/√Hz	<i>Region of white noise</i>
Broad-band Noise (10 Hz to $f_T$ )	<i>depends on the customer's specified frequency bandwidth</i>				<i>RMS noise; see note 6</i>
Resolution					<i>See notes 5 - 9</i>
<b>Typical frequency response</b>					
Frequency Bandwidth [ $f_T$ ]	0.5 kHz 1.0 kHz max 2.5 kHz			max 0.5 kHz	<i>Other frequency bandwidths available; Sensitivity decrease -3dB; See note 10</i>
Output resistance	< 10 Ohms, short circuit proof				
<b>Temperature output</b>					
Ground-referred voltage	$V_T [mV] = (T [°C] \pm 1°C) \times 50[mV/°C]$				

**MODULE E: MECHANICAL AND ELECTRICAL SPECIFICATIONS:**

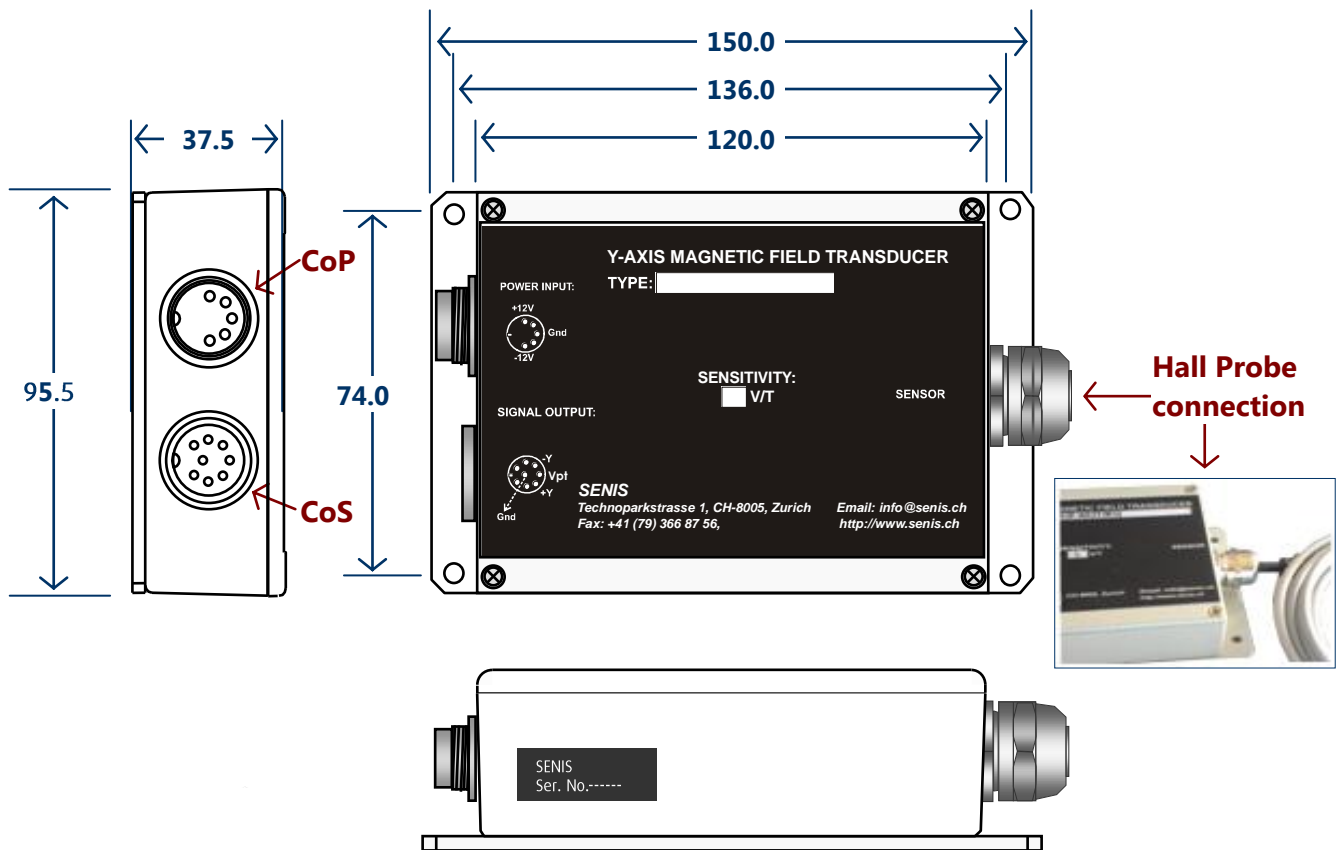

Figure 4. Structure, dimensions and tolerances of the single-channel analogue electronic module

<b>Module E</b>	High mechanical strength, electrically shielded aluminum case [95 <b>W</b> x 120 <b>L</b> x 37 <b>H</b> mm] with mounting provision (see Fig. 4)	
<b>Connector CoS</b> DIN KJV81, 8 poles (Mating plug SV81)	Field signal Y+, Y- Temperature signal Signal common (GND)	Pins 5 and 4, respectively Pin 2 Pin 8
<b>Connector CoP</b> DIN SFV50, 5 poles (Mating plug KV50)	Power, +12V Power, -12V Power common (GND)	Pin 3 Pin 1 Pin 2
<b>Connector CoH</b>	Fixed connection, Cable gland, MS PG11	
<b>DC Power</b>	Voltage: Max. ripple: Current:	$\pm 12V$ nominal, $\pm 2\%$ 80 mVpp ca. $\pm 80$ mA

**Environmental Parameters:**

Operating Temperature	+5°C to +45°C	Option: up to +100°C for the H-Module
Storage Temperature	-20°C to +85°C	

**Magnetic Flux Density (B) units (T-tesla, G-gauss) conversion:**

- 1 T = 10 kG
- 1 mT = 10 G
- 1  $\mu$ T = 10 mG

**OPTIONS:****DC Calibration**

The calibration table of the transducer can be ordered as an option. The calibration table is an Excel-file, providing the actual values of the transducer output voltage for the test DC magnetic flux densities measured by a reference NMR Teslameter. The standard calibration table covers the linear range of magnetic flux density  $\pm B_{LR}$  in the steps of  $B_{LR}/10$ . Different calibration tables are available upon request. By the utilisation of the calibration table, the accuracy of DC and low-frequency magnetic measurement can be increased up to the limit given by the resolution (see Notes 1 and 5  $\div$  9).

**AC Calibration - Frequency Response**

Another option is the calibration table of the frequency response. This is an Excel file, providing the actual values of the transducer transfer function (complex sensitivity and Bode plots) for a reference AC magnetic flux density. The standard frequency response calibration table covers the transducer bandwidth, from DC to  $f_T$ , in the steps of  $f_T/10$ . Different calibration tables are also available upon request. Utilisation of the frequency calibration table allows an accuracy increase of the AC magnetic measurements almost up to the limit given by the resolution (see Notes 1 and 5  $\div$  10).

SENIS Single-Axis Hall probe works well in the B-frequency range from DC to  $f_T$  (-3dB point) (B being the density of the measured magnetic flux). In addition to the Hall voltage, at high B-frequencies also inductive signals are generated at the connection probe-thin cable. Moreover, the probe, the cable and the electronics in the E-module behave as a low-pass filter. As a result, the transducer has the "complex" sensitivity of the form:

$$S = S_H + jS_I$$

Here:

- $S_H$  represents sensitivity for the output signal in phase with the magnetic flux density (that is the real part of the transfer function);
- $S_I$  is the sensitivity with the 90° phase shift with respect to the magnetic flux density (i.e., the imaginary part of the transfer function).

Calibration data can be ordered for  $S_H$  and  $S_I$  for the transverse (Y) axis (as an option). This allows the customer to deduce accurate values of the measured magnetic flux density at even high frequencies by an appropriate mathematical treatment of the transducer output voltage  $V_{Out}$ .

**SENIS AG**

Grabenstrasse 25, 6340 Baar, Switzerland  
Web : [www.senis.ch](http://www.senis.ch) ; Email: [transducers@senis.ch](mailto:transducers@senis.ch)  
Phone: +41 (44) 508 7029; Fax: +41 (43) 205 2638

North American Distributor: **GMW Associates**  
955 Industrial Road, San Carlos, CA 94070, USA  
Web: [www.gmw.com](http://www.gmw.com) ; Email: [sales@gmw.com](mailto:sales@gmw.com)  
Phone: +1 (650) 802 8292; Fax: +1 (650) 802 8298

**Rev.01,**  
Nov. 2012  
Page 6/8

**NOTES:**

- 1) The **accuracy** of the transducer is defined as the maximum difference between the actual measured magnetic flux density and that given by the transducer. In other words, the term accuracy expresses the maximum measurement error. After zeroing the offset at the nominal temperature, the worst case relative measurement error of the transducer is given by the following expression:

$$\text{Max. Relative Error: M.R.E.} = S_{err} + NL + 100 \times \text{Res} / B_{LR} \quad [\text{unit: \% of } B_{LR}] \quad \text{Eq. [1]}$$

Here,  $S_{err}$  is the tolerance of the sensitivity (relative error in percents of  $S$ ),  $NL$  is the maximal relative nonlinearity error (see note 4),  $\text{Res}$  is the absolute resolution (Notes 6÷10) and  $B_{LR}$  is the linear range of magnetic flux density.

- 2) The output of the measurement channel has two terminals and the output signal is the (differential) voltage between these two terminals. However, each output terminal can be used also as a single-ended output relative to common signal. In this case the sensitivity is approx. 1/2 of that of the differential output (*Remark: The single-ended output is not calibrated*).
- 3) The **sensitivity** is given as the nominal slope of an ideal linear function  $V_{out} = f(B)$ , i.e.

$$V_{out} = S \times B \quad \text{Eq. [2]}$$

where  $V_{out}$ ,  $S$  and  $B$  represent transducer output voltage, sensitivity and the measured magnetic flux density, respectively.

- 4) The **nonlinearity** is the deviation of the function  $B_{measured} = f(B_{actual})$  from the best linear fit of this function. Usually, the maximum of this deviation is expressed in terms of percentage of the full-scale input. Accordingly, the nonlinearity error is calculated as follows:

$$NL = 100 \times \left[ \frac{V_{out} - V_{off} - B}{S'} \right]_{\max} / B_{LR} \quad (\text{for } -B_{LR} < B < B_{LR}) \quad \text{Eq. [3]}$$

*Notation:*

$B$  = Actual testing DC magnetic flux density given by a reference NMR Teslameter

$V_{out}(B) - V_{off}$  = Corresponding measured transducer output voltage after zeroing the Offset

$S'$  = Slope of the best linear fit of the function  $f(B) = V_{out}(B) - V_{off}$  (i.e. the actual sensitivity)

$B_{LR}$  = Linear range of magnetic flux density

**Tolerance of sensitivity** can be calculated as follows:

$$\text{Tolerance of sensitivity} = 100 \times |S' - S| / S \quad \text{Eq. [4]}$$

- 5) This is the "6-sigma" peak-to-peak span of offset fluctuations with sampling time  $\Delta t = 0.05s$  and total measurement time  $t = 100s$ . The measurement conditions correspond to the frequency bandwidth from 0.01Hz to 10Hz. The "6-sigma" means that in average 0.27% of the measurement time offset will exceed the given peak-to-peak span. The corresponding root mean square (RMS) noise equals 1/6 of "Offset fluctuation & drift".
- 6) Total output RMS noise voltage (of all frequencies) of the transducer. The corresponding peak-to-peak noise is about 6 times the RMS noise. See also Notes 7 and 8.
- 7) Maximal signal bandwidth of the transducer, determined by a built-in low-pass filter with a cut-off frequency  $f_T$ . In order to decrease noise or avoid aliasing, the frequency bandwidth may be limited by passing the transducer output signal through an external filter (see Notes 8 and 9).

- 8) **Resolution** of the transducer is the smallest detectable change of the magnetic flux density that can be revealed by the output signal. The resolution is limited by the noise of the transducer and depends on the frequency band of interest.

The **DC resolution** is given by the specification "Offset fluctuation & drift" (see also Note 5). The worst-case (**AC resolution**) is given by the specification "Broad-band noise" (see also Note 6). The resolution of a measurement can be increased by limiting the frequency bandwidth of the transducer. This can be done by passing the transducer output signal through a hardware filter or by averaging the measured values. (Caution: filtering produces a phase shift, and averaging a time delay!) The RMS noise voltage (i.e. resolution) of the transducer in a frequency band from  $f_L$  to  $f_H$  can be estimated as follows:

$$V_{nRMS-B} \approx \sqrt{NSD_{1f}^2 \times 1\text{Hz} \times \ln\left(\frac{f_H}{f_L}\right) + 1.57 \times NSD_W^2 \times f_H} \quad \text{Eq. [5]}$$

Here  $NSD_{1f}$  is the  $1/f$  noise voltage spectral density (RMS) at  $f=1\text{Hz}$ ;  $NSD_w$  is the RMS white noise voltage spectral density;  $f_L$  is the low, and  $f_H$  is the high-frequency limit of the bandwidth of interest; and the numerical factor 1.57 comes under the assumption of using a first-order low-pass filter. For a DC measurement:  $f_L=1/\text{measurement time}$ . The high-frequency limit can not be higher than the cut-off frequency of the built-in filter  $f_T$ :  $f_H \leq f_T$ . If the low-frequency limit  $f_L$  is higher than the corner frequency  $f_C$ , then the first term in Eq. (5) can be neglected; otherwise: if the high-frequency limit  $f_H$  is lower than the corner frequency  $f_C$ , then the second term in Eq. (5) can be neglected. The corresponding peak-to-peak noise voltage can be calculated according to the "6-sigma" rule, i. e.,  $V_{nP-P-B} \approx 6 \times V_{nRMS-B}$ .

- 9) According to the sampling theorem, the sampling frequency must be at least two times higher than the highest frequency of the measured magnetic signal. Let us denote this signal sampling frequency by  $f_{samS}$ . However, in order to obtain the best signal-to-noise ratio, it is useful to allow for over-sampling (this way we avoid aliasing of high-frequency noise). Accordingly, for best resolution, the recommended physical sampling frequency of the transducer output voltage is  $f_{samP} > 5 \times f_T$  (or  $f_{samP} > 5 \times f_H$ ), if an additional low-pass filter is used (see Note 7). The number of samples can be reduced by averaging every  $N$  subsequent samples,  $N \leq f_{samP} / f_{samS}$ .
- 10) When measuring fast-changing magnetic fields, one should take into account the transport delay of the Hall signals, small inductive signals generated at the connections Hall probe–thin cable, and the filter effect of the electronics in the E-Module. Approximately, the transducer transfer function is similar to that of a first-order Butterworth low-pass filter, with the bandwidth from DC to  $f_T$ . The filter attenuation is -20 db/dec. (-6 db/oct.). The calibration table of the frequency response is available as an option.