

HallinSight® Key Specifications

- Three-axis Magnetometers

1-1 HALLINSIGHT® SENSOR MODULES INTRODUCTION

Three-axis Hall Magnetometers are used to measure magnetic flux density. Simultaneous measurement of all three components of the magnetic field provides the total field no matter the probe's orientation, which significantly facilitates many measurement tasks such as field mapping.

Different HallinSight® Sensor Modules are available. Hardware geometrics, coordinate systems and technical features are specified below. All geometric measures are in mm; coordinate systems (CS) are right-handed (order: x-y-z).

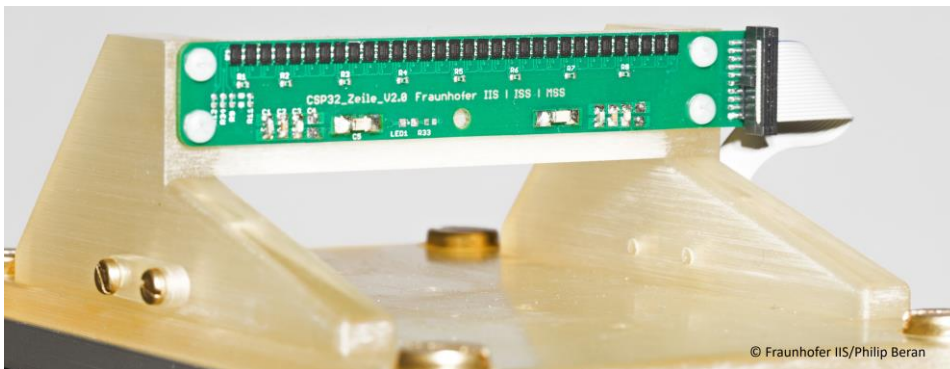

HallinSight® 32X2 pixels sensor array



HallinSight® 32X32 pixels sensor array

1-2 SOFTWARE

| | |
|-------------------------------|--|
| Software functions: | <p>Meter mode:</p> <ul style="list-style-type: none"> • Cartesian coordinates B_x, B_y and B_z • Spherical coordinate system, B_{abs}, Phi and Theta <p>Mapping mode:</p> <ul style="list-style-type: none"> • 3D vector plot • 3D surface plot • 2D surface plot • 2D contour plot • 2D arrow plot • Section graph <p>Control of range, trigger, acquisition rates, oversampling</p> <p>Hold, Max, and Alarm functions</p> <p>Zero offset correction</p> <p>Save memory or disk</p> <p>Help</p> |
| COM port | <p>Automated or manual COM port selection</p> <p>Possibility to connect multiple HallinSight® sensor arrays on the same PC using different COM ports</p> |
| Operating system requirements | <p>Windows 7 (32bit or 64bit)</p> <p>Windows 10 (32bit or 64bit)</p> |
| Hardware requirements | <p>USB 2.0 or higher</p> <p>Dual-core processor with 2 GHz or higher</p> <p>Minimum 2 GB internal RAM</p> <p>Monitor with screen resolution of at least 1280 x 800</p> <p>Recommended: Dedicated GPU</p> |

1-3 MEASUREMENT

| | |
|----------------------------------|--|
| Data output | <ul style="list-style-type: none"> - Bx, By, Bz, Babs, Phi, Theta and derivatives - Temperature in the raw data - Further data output <ul style="list-style-type: none"> - Plot graphics - Section data - Single, continuous and transfer log function - Internal time stamp |
| Protocol | Custom protocol using ASCII commands for operation and ASCII as well as binary feedback |
| Connector | USB Type-A |
| Power | Global power supply, 5 V, max 6 V USB 2.0 bus-powered, 5 V, Max 5.25 V |
| Supply voltage of sensors | 3.3, max 3.6 V |
| Current consumption | 10 mA, max 15 mA per sensor during measurement Total current consumption: <ul style="list-style-type: none"> - 32x2 line array @ 250 Hz: 0.5 A - 32x32 plane array @ 25 Hz: 1 A |
| Trigger In/Out level | 3.3 V typical, max 5 V |
| Operating temperature | 10°C to +30°C |
| Storage temperature | 0°C to +50°C |
| Warranty | Two years |
| Recommended calibration interval | 18 months |
| Maintenance | Firmware and software upgradeable by end-user |

Operating Conditions

The HallinSight® Magnetic Measurement System was designed for indoor use in laboratories and under moderate conditions. It is not designed for outdoor use or rough conditions. The magnetic sensors are calibrated for use within an ambient temperature range from 10 °C to 30 °C. As the sensors heat up during measurement, the sensor temperature should not exceed 55 °C. If the sensors are operated outside this range you a temperature warning is displayed because the best metering precision cannot be guaranteed.

Please note that 3D-printed parts of the camera housing of some systems are only approved for temperatures up to 60 °C.

1-4 GEOMETRIC SENSOR DETAILS

The actual sensitive area is located on the bottom side of the soldered IC. The circuit board thickness is highly variable depending on the system. In contrast, the chip thickness has very low tolerance.

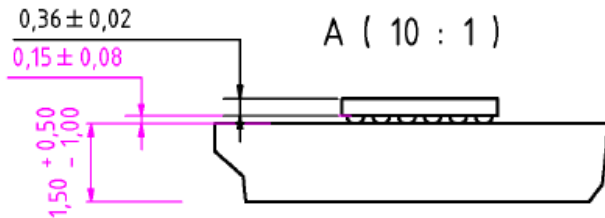

Every FH5401c sensor contains two 3-D Hall sensors (pixels) for vectorial measurement of magnetic fields. Geometrical dimensions of the sensor and the position of the actual sensitive sensor area can be extracted from following figure and table.

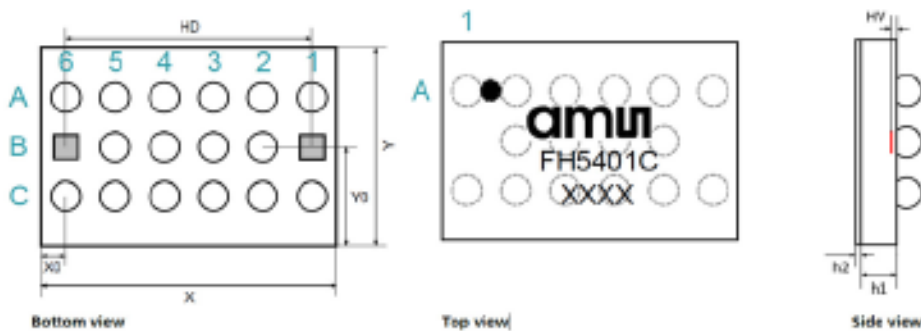

FC5401c sensor chip dimensions

| | | |
|-------------------------------|-----------|---|
| Length | X | 3035 μm |
| Width | Y | 2035 μm |
| Distance between Hall sensors | HD | 2500 μm |
| x-Distance Edge-Sensor | X0 | 285 μm |
| y-Distance Edge-Sensor | Y0 | 1035 μm |
| Hall Sensor vertical | HV | 30 μm |
| Active sensor volume | L x W x H | 200 μm x 200 μm x 5 μm |
| Total chip thickness | h1 + h2 | 360 μm |

1-5 CALIBRATION

All HallinSight® Magnetic Measurement Systems are fully calibrated in a magnetic reference field. The following characteristics are valid for the standard configuration of the sensors with a metering range of 100 mT. Magnetic resolution, noise and offset are directly related to metering range and scale with lower or greater ranges. All specifications are valid for operation in ambient temperature range.

| | |
|--------------------------------|--|
| Magnetic resolution | 4 μ T no avg. |
| Magnetic accuracy | 0.1 % |
| Magnetic offset | <25 μ T without adjustment (zero function) |
| Magnetic Remanence | <1 μ T |
| Magnetic noise | 25 μ T RMS |
| Measurement integration time | 2 ms no avg. |
| Sensor lateral error on PCB | <50 μ m |
| Sensor vertical error on PCB | <10 μ m |
| Sensor rotational error on PCB | <0.1° corrected |

- HallinSight® sensor arrays

2-1 HALLINSIGHT® LINEAR SENSOR ARRAY 32X2 PIXEL ARRAY

The sensor spacing in X- and Y-direction is 2.5 mm. The measuring distance in

Z-direction is given by the sensor package and amounts about 360 μ m (see chapter 5).

The 32x2 HallinSight Pixel Line Array is delivered without a case for flexible integration in systems. The PCB provides mounting holes for fixation in customer applications. For dimensions of PCB and mounting see following drawings (all dimensions in mm).

This HallinSight system is split in two parts: The PCB containing sensors, and the interface box that is connected to the sensor PCB with a ribbon cable and provides the USB connector for power supply and communication.

| | |
|---|--|
| Scope of delivery | 64 sensor array PCB Interface box Flat ribbon cable (2 m) USB cable (1.8 m) SB stick with documentation and software |
| Sensor | 64 3-axis Hall sensors Integrated temperature sensor |
| Ranges | 100 mT, 200 mT, 800 mT, 2 T You should try to use the lower ranges whenever possible |
| Measurement rate | Max 250 Hz, no sampling, no interpolation |
| Units | mT (µT in rawdata log files) |
| Calibration range | 15 mT (up to 2 T in development) |
| Resolution | 4 µT |
| Accuracy | ±0.1 % |
| Axis orientation relative to the sensor array | |
| Sensor Field sensitive volume | 77.5 mm x 2.5 mm x 100 µm (100 µm due to PCB flatness) |
| Sensor lateral error on PCB | <50 µm |
| Sensor vertical error on PCB | <10 µm |
| Sensor rotational error on PCB | <0.1° corrected |
| Weight | 6.5 g PCB 24 g PCB + 1 m ribbon cable |

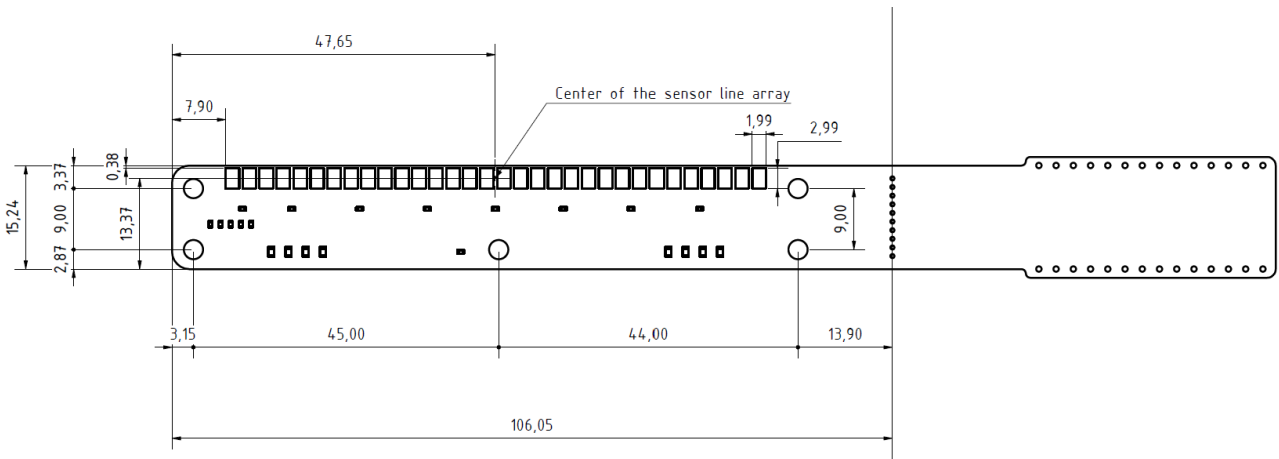
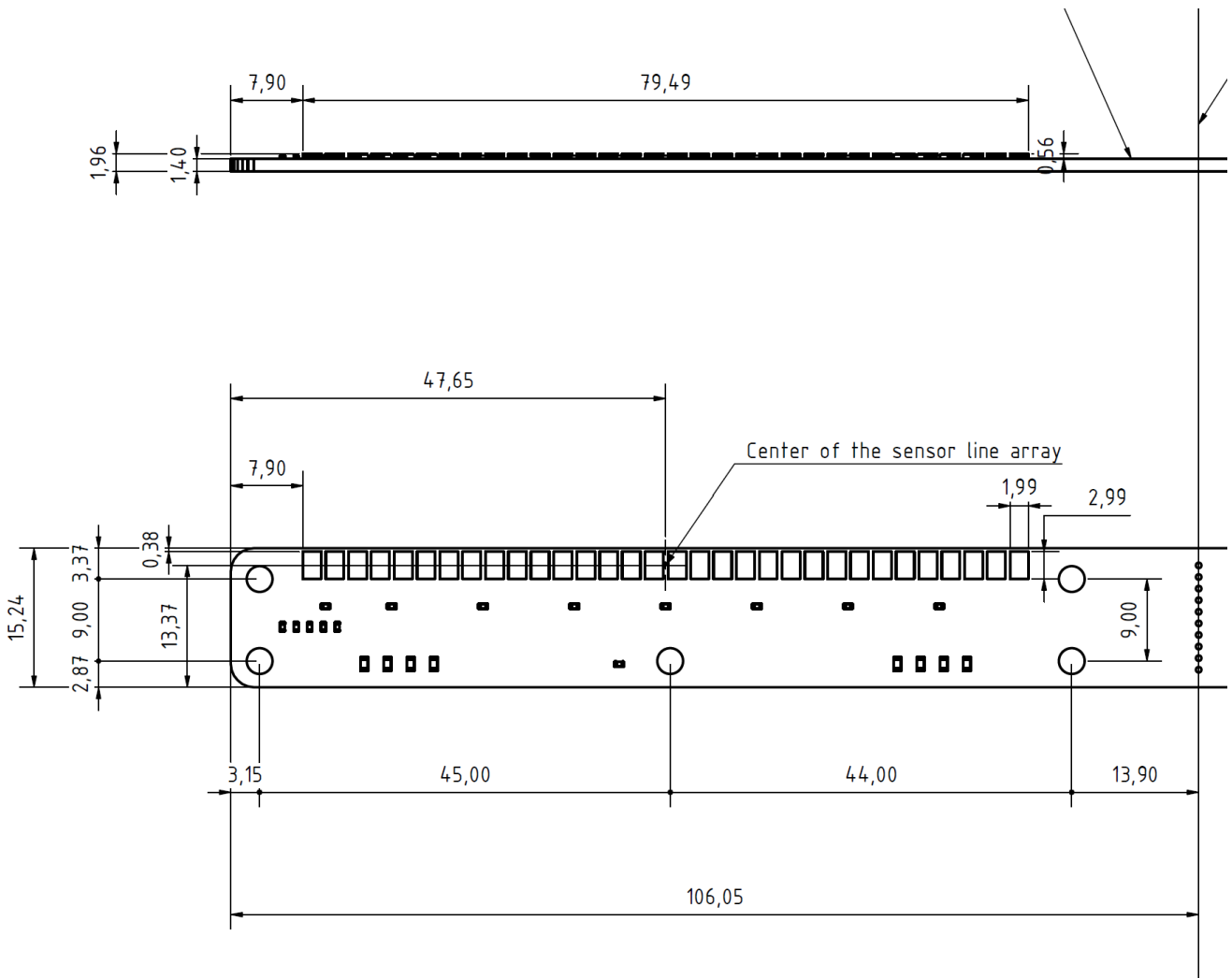

Interface box:

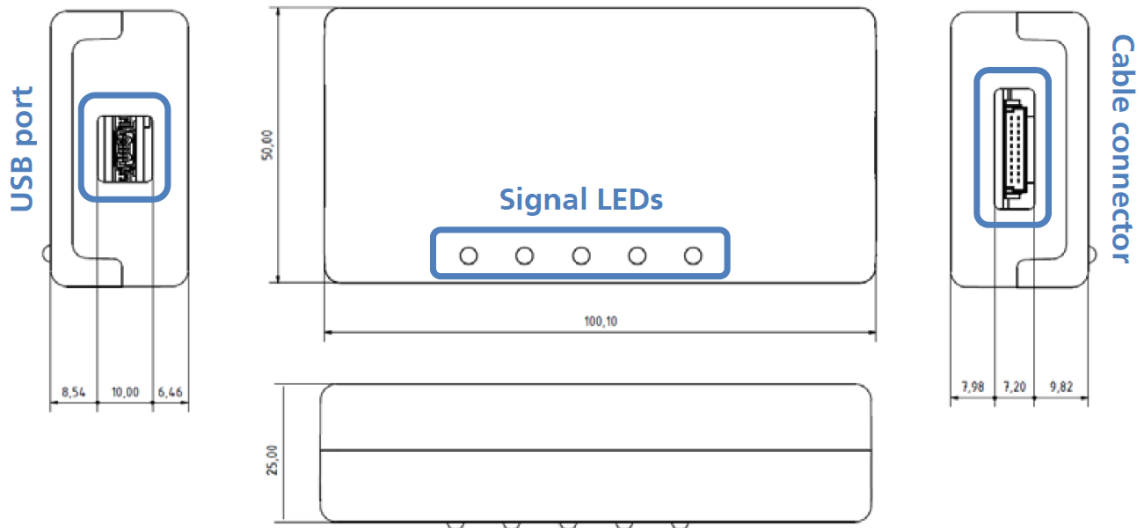

2-2 HALLINSIGHT® LINEAR SENSOR ARRAY 32X32 PIXEL PLANAR ARRAY

The sensor spacing in X- and Y-direction is 2.5 mm. Measuring distance in Z-direction (distance between active sensor and case) is also 2.5 mm.

The 32x32 HallinSight Pixel Array is delivered with an aluminum case. The case provides mounting holes for integration in customer applications. For dimensions of case and mounting see following drawings (all dimensions in mm).

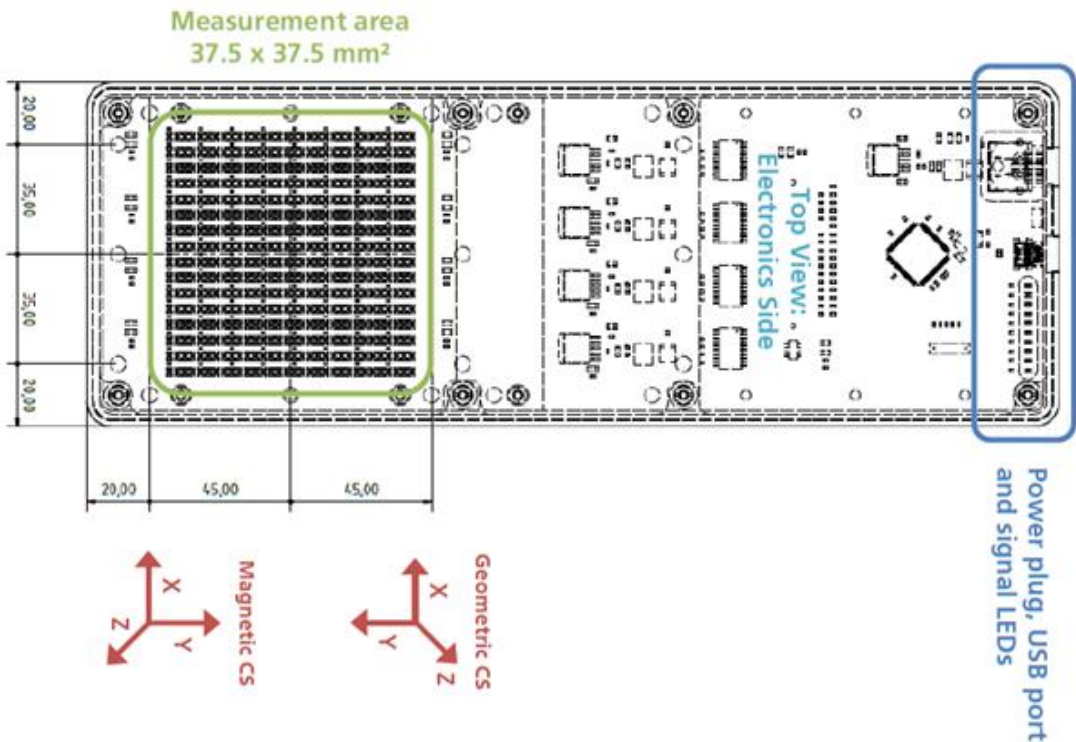
| | |
|---|--|
| Scope of delivery | 1024 sensor array in aluminium case USB cable (1.8 m) Suitable power supply (5 V) USB stick with documentation and software |
| Sensor | 1024 3-axis Hall sensors Integrated temperature sensor |
| Ranges | 100 mT, 200 mT, 800 mT, 2 T You should try to use the lower ranges whenever possible |
| Measurement rate | Max 25 Hz, no sampling, no interpolation |
| Units | mT (μ T in rawdata log files) |
| Calibration range | 15 mT (up to 2 T in development) |
| Resolution | 4 μ T |
| Accuracy | ± 0.1 % |
| Axis orientation relative to the sensor array |  <p>The drawing shows the top view of the electronics side of the device. A green rectangular area in the center is labeled 'Measurement area 37.5 x 37.5 mm²'. The overall dimensions of the device are 20.00 mm by 35.00 mm by 35.00 mm by 20.00 mm. The sensor array is 45.00 mm by 45.00 mm. Two coordinate systems are shown: 'Magnetic CS' and 'Geometric CS'. The 'Magnetic CS' has X pointing up, Y pointing right, and Z pointing out of the page. The 'Geometric CS' has X pointing up, Y pointing left, and Z pointing out of the page. On the right side, there is a blue box around the 'Power plug, USB port and signal LEDs'.</p> |

| | |
|--------------------------------|---|
| Sensor Field sensitive volume | 77.5 mm x 77.5 mm x 100 µm (100 µm due to PCB flatness) |
| Sensor lateral error on PCB | <50 µm |
| Sensor vertical error on PCB | <10 µm |
| Sensor rotational error on PCB | <0.1° corrected |
| Weight | 2.0 kg lighter version in development |

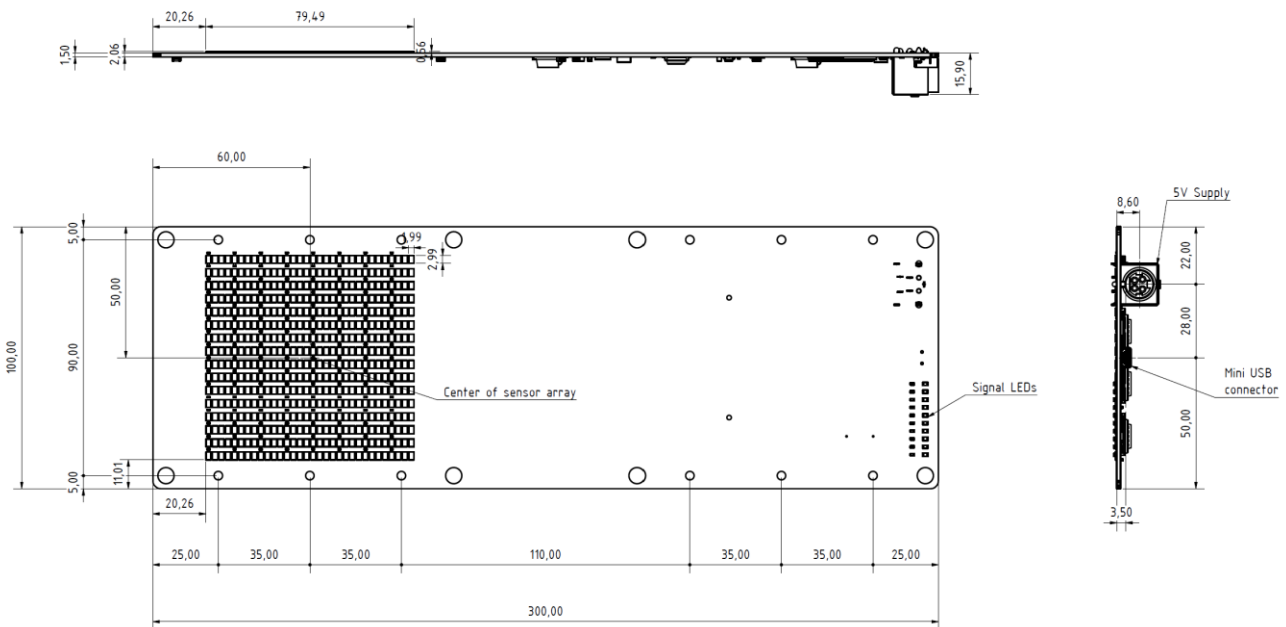

2-3 HALLINSIGHT® LINEAR SENSOR ARRAY 16X16 PIXEL PLANAR ARRAY

Details pending